

GR3 3A-1EC

Previous description	Max. Resistance	FAP9 (A)	FAP13 (B)	FAP15 (C)	FAP17 (D)	FAP21 (E)	FAP30 (G)
Body size		3/8"	1/2"	5/8"	3/4"	1"	1-1/2"
GR3-9ZN	8000 N	3	A				



DRAWING



CONFIGURATIONS

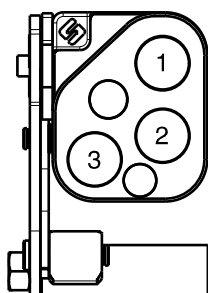

Pos	Possible configurations	
	Coupling size	Predisposition for electrical connector
1	FAP9AZN	-
2	FAP9AZN	-
3	FAP9AZN	YES

MultiCoupling (couplings included)		
Code	Name	Description
870001040	MULTI COMPLETE GR3 3A	2 FAP9A 3/8 BSP - 1 FAP9A 1/2 BSP - CAP
870001043	MULTI COMPLETE GR3 3A	3 FAP9A 3/8 BSP - CAP
870001044	MULTI COMPLETE GR3 3A	3 FAP9A 1/2 BSP - CAP
870001140	MULTI FIX GR3 3A	2 FAP9A 3/8 BSP - 1 FAP9A 1/2 BSP
870001143	MULTI FIX GR3 3A	3 FAP9A 3/8 BSP
870001144	MULTI FIX GR3 3A	3 FAP9A 1/2 BSP
870001240	MULTI MOBILE GR3 3A	2 FAP9A 3/8 BSP - 1 FAP9A 1/2 BSP
870001243	MULTI MOBILE GR3 3A	3 FAP9A 3/8 BSP
870001244	MULTI MOBILE GR3 3A	3 FAP9A 1/2 BSP

MultiCoupling spare parts (couplings not included)		
Code	Name	
806000270	MULTI FIX EMPTY GR3 3A-1EC	
806000271	MULTI MOBILE EMPTY GR3 3A-1EC	
815606242	CAP FIX MULTICOUPLING GR 90x74	
815606243	PARKING STATION MOBILE MULTICOUPLING GR 100x75	
815701053	SPARE KIT LEVER GROUP GR 200x95	

Custom configurations available upon request

Fixed and mobile multicoupling

2,0 Kg and 0,9 Kg

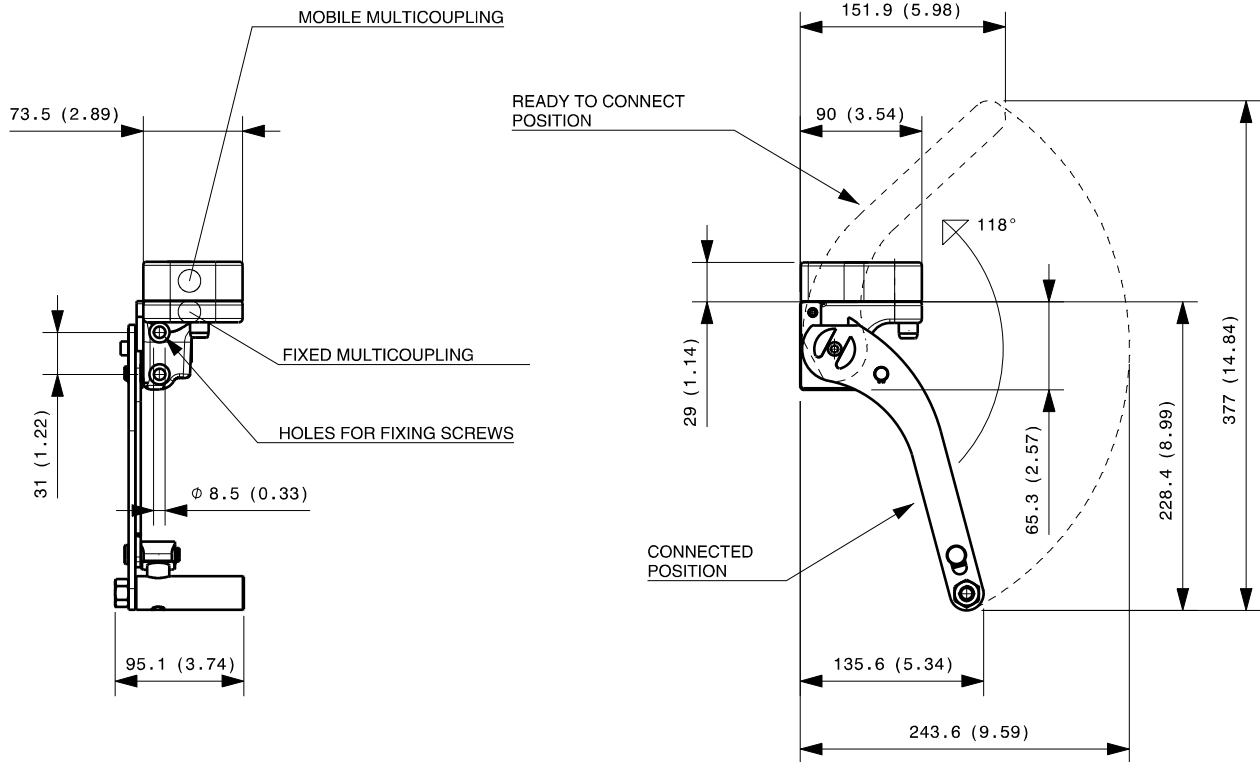

Dimensions in millimeters (inch)

Cap for fixed multicoupling 0,4 Kg

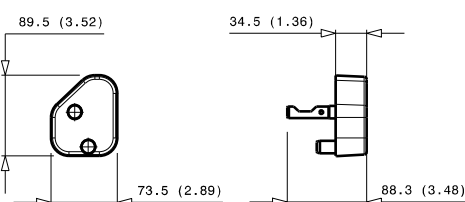

Parking station for mobile multicoupling 0,6 Kg

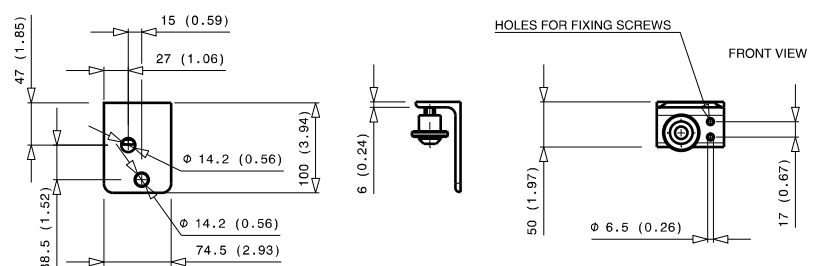

GR3 3B-1EC

Previous description	Max. Resistance	FAP9 (A)	FAP13 (B)	FAP15 (C)	FAP17 (D)	FAP21 (E)	FAP30 (G)
Body size		3/8"	1/2"	5/8"	3/4"	1"	1-1/2"
GR3-13ZN	18000 N		3				



DRAWING



CONFIGURATIONS

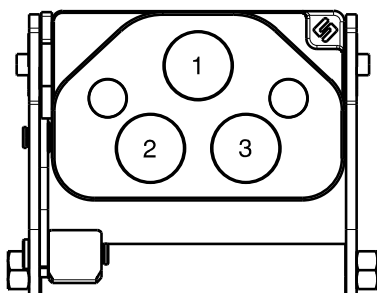

Pos	Possible configurations	
	Coupling size	Predisposition for electrical connector
1	FAP13ZN	-
2	FAP13ZN	YES
3	FAP13ZN	-

MultiCoupling (couplings included)		
Code	Name	Description
870003017	MULTI COMPLETE GR3 3B	1 FAP13 1/2 BSP - 2 FAP13 3/4 BSP - CAP
870003020	MULTI COMPLETE GR3 3B	3 FAP13 1/2 BSP - CAP
870003021	MULTI COMPLETE GR3 3B	3 FAP13 3/4 BSP - CAP
870003117	MULTI FIX GR3 3B	1 FAP13 1/2 BSP - 2 FAP13 3/4 BSP
870003120	MULTI FIX GR3 3B	3 FAP13 1/2 BSP
870003122	MULTI FIX GR3 2B	2 FAP13 3/4 BSP
870003123	MULTI FIX GR3 2B-1EC	2 FAP13 1/2 BSP - 1 EC6
870003217	MULTI MOBILE GR3 3B	1 FAP13 1/2 BSP - 2 FAP13 3/4 BSP
870003220	MULTI MOBILE GR3 3B	3 FAP13 1/2 BSP
870003223	MULTI MOBILE GR3 2B-1EC	2 FAP13 1/2 BSP - 1 EC6

MultiCoupling spare parts (couplings not included)	
Code	Name
806000272	MULTI FIX EMPTY GR3 3B-1EC
806000273	MULTI MOBILE EMPTY GR3 3B-1EC
815606248	CAP FIX MULTICOUPLING GR 139x90
815606249	PARKING STATION MOBILE MULTICOUPLING GR 140x100
815701052	SPARE KIT LEVER GROUP GR 200x176

Custom configurations available upon request

Fixed and mobile multicoupling

3,8 Kg and 1,8 Kg

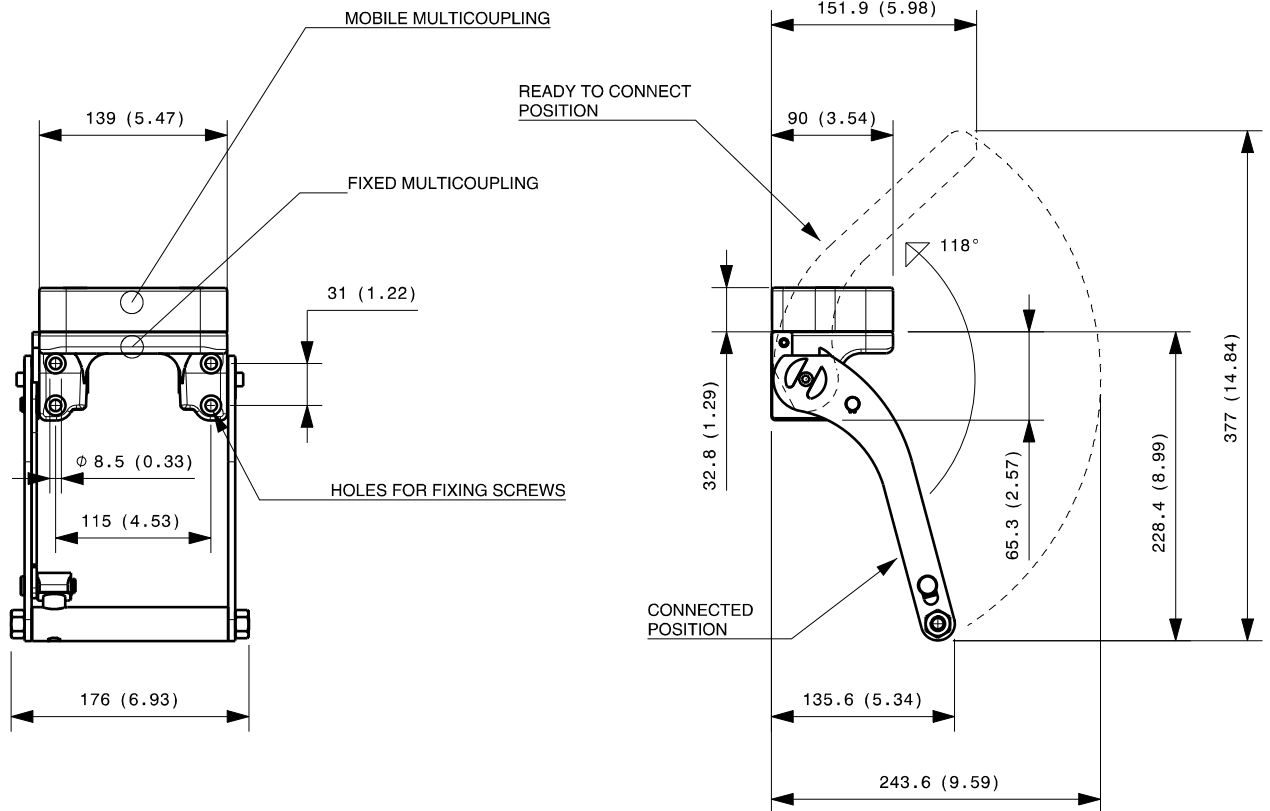

Dimensions in millimeters (inch)

Cap for fixed multicoupling 0,6 Kg

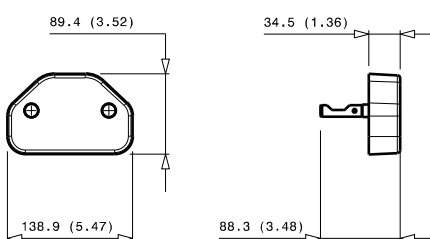

Parking station for mobile multicoupling 1,1 Kg

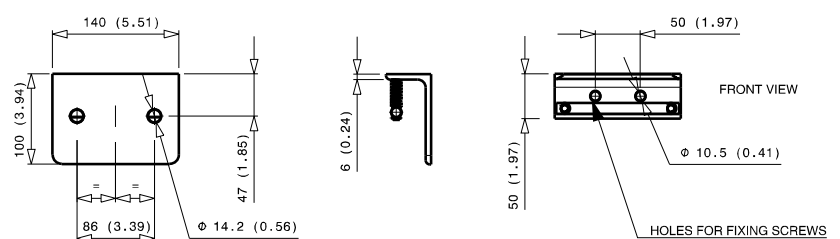

GR3 1A-2E-1EC

Previous description	Max. Resistance	FAP9 (A)	FAP13 (B)	FAP15 (C)	FAP17 (D)	FAP21 (E)	FAP30 (G)
Body size		3/8"	1/2"	5/8"	3/4"	1"	1-1/2"
GRK3ZN	23000 N	1	D			2	



DRAWING

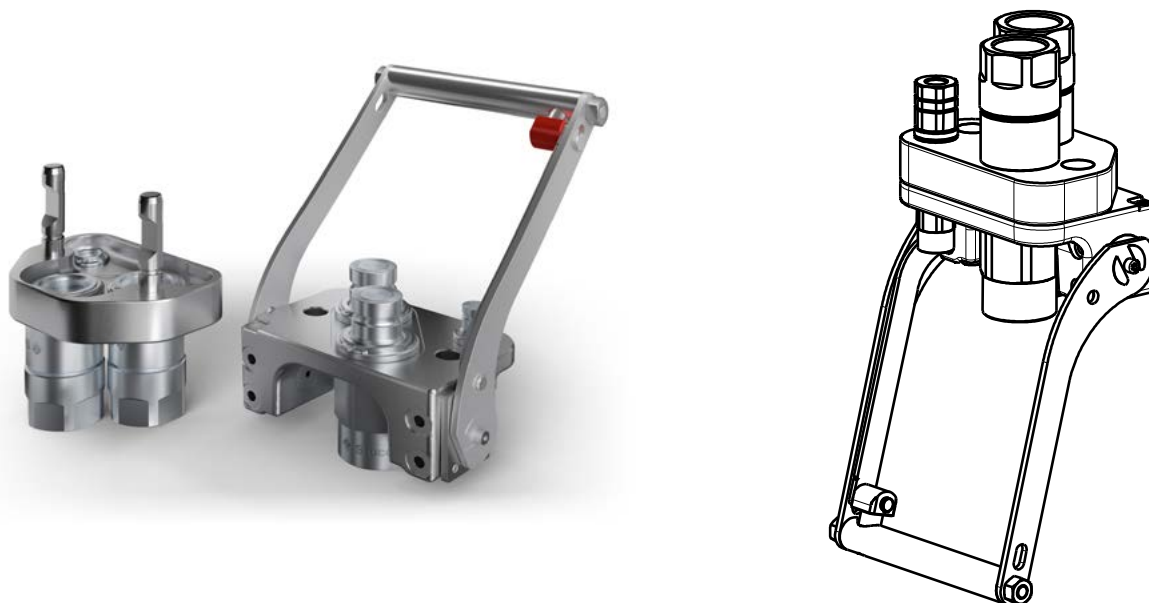

CONFIGURATIONS

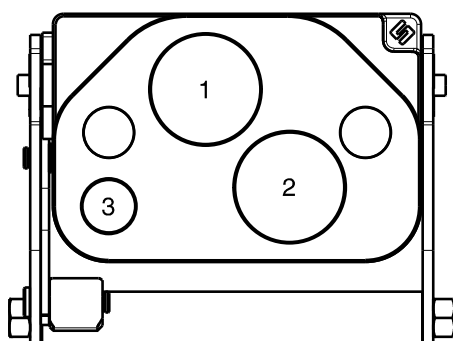

Possible configurations		
Pos	Coupling size	Predisposition for electrical connector
1	FAP21ZN	-
2	FAP21ZN	-
3	FAP9DZN	YES

MultiCoupling (couplings included)		
Code	Name	Description
870015075	MULTI COMPLETE GR3 1A-2E	1 FAP9D 3/8 BSP - 2 FAP21 1 BSP - CAP
870015083	MULTI COMPLETE GR3 1A-2E	1 FAP9D 3/8 BSP - 2 FAP21 1-1/4 BSP - CAP
870016052	MULTI COMPLETE GR3 1A-2E	1 FAP9D 1/2 BSP - 2 FAP21 1 BSP - CAP
870016001	MULTI COMPLETE GR3 2E	2 FAP21 1-1/4 BSP - CAP
870015175	MULTI FIX GR3 1A-2E	1 FAP9D 3/8 BSP - 2 FAP21 1 BSP
870016101	MULTI FIX GR3 2E	2 FAP21 1-1/4 BSP
870015275	MULTI MOBILE GR3 1A-2E	1 FAP9D 3/8 BSP - 2 FAP21 1 BSP
870016201	MULTI MOBILE GR3 2E	2 FAP21 1-1/4 BSP

MultiCoupling spare parts (couplings not included)		
Code	Name	
806000310	MULTI FIX EMPTY GR3 1A-2E-1EC	
806000311	MULTI MOBILE EMPTY GR3 1A-2E-1EC	
815606260	CAP FIX MULTICOUPLING GR 175x117 V02	
815606261	PARKING STATION MOBILE MULTICOUPLING GR 180x120 V02	
815701055	SPARE KIT LEVER GROUP GR 250x212	

Custom configurations available upon request

Fixed and mobile multicoupling

5,7 Kg and 2,8 Kg

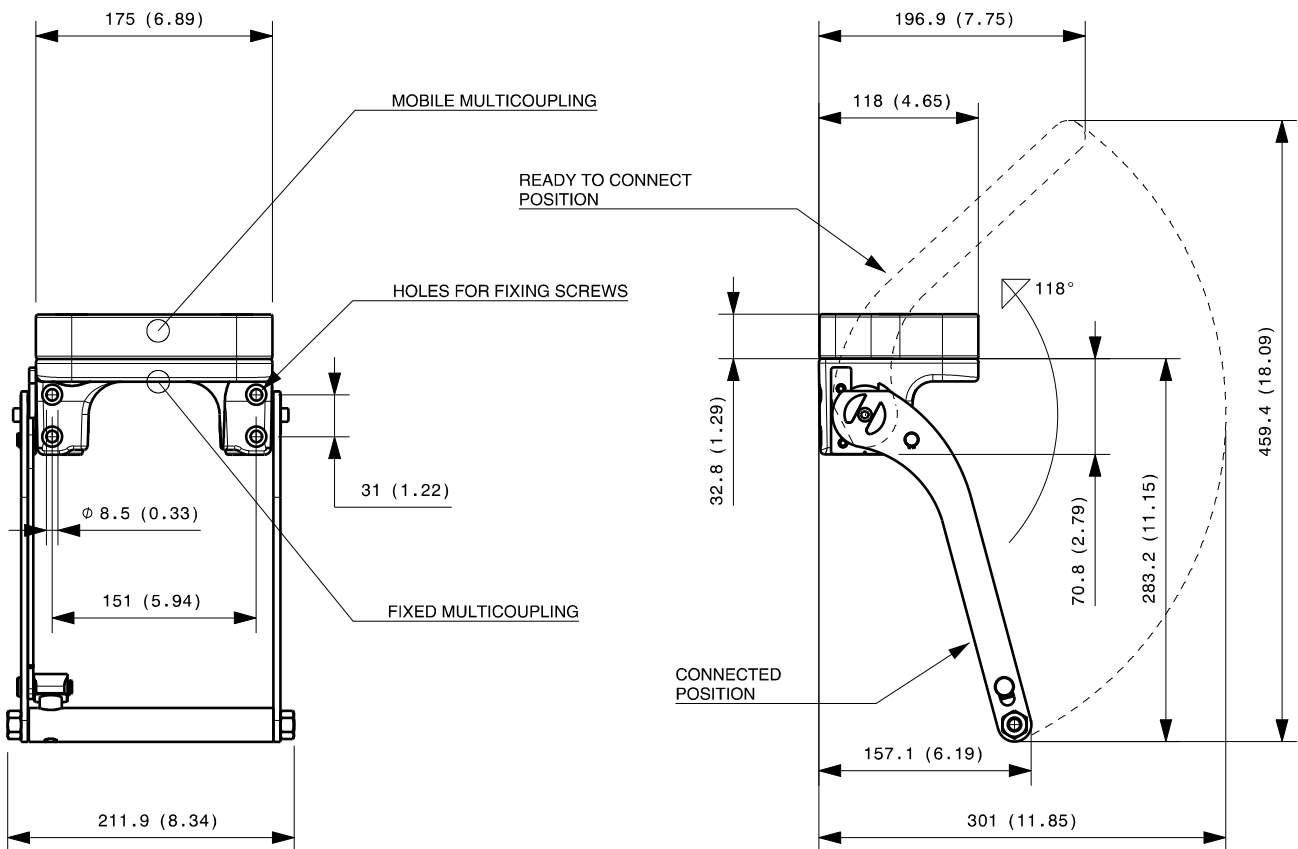

Dimensions in millimeters (inch)

Cap for fixed multicoupling 1,2 Kg

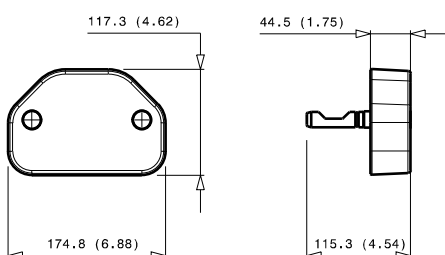

Parking station for mobile multicoupling 2,4 Kg

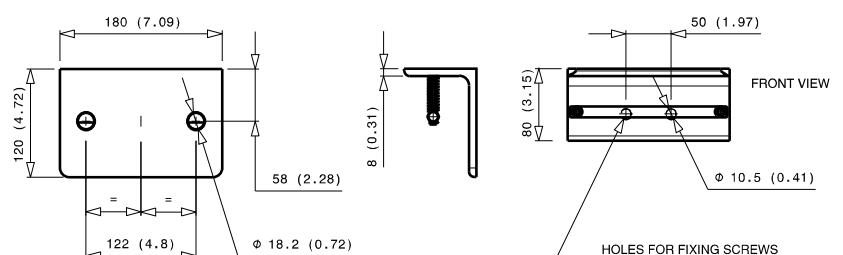

GR3 2B-1C-2EC

Previous description	Max. Resistance	FAP9 (A)	FAP13 (B)	FAP15 (C)	FAP17 (D)	FAP21 (E)	FAP30 (G)
GR13	18000 N	3/8"	1/2"	5/8"	3/4"	1"	1-1/2"
			2	1			



DRAWING

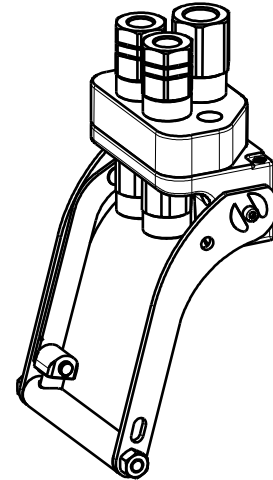

CONFIGURATIONS

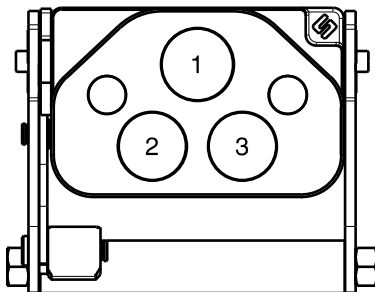

Possible configurations		
Pos	Coupling size	Predisposition for electrical connector
1	FAP15ZN	-
2	FAP13ZN	YES
3	FAP13ZN	YES

MultiCoupling (couplings included)

Code	Name	Description
870015065	MULTI COMPLETE GR3 2B-1C	2 FAP13 1/2 BSP - 1 FAP15 3/4 BSP - CAP
870015165	MULTI FIX GR3 2B-1C	2 FAP13 1/2 BSP - 1 FAP15 3/4 BSP
870015265	MULTI MOBILE GR3 2B-1C	2 FAP13 1/2 BSP - 1 FAP15 3/4 BSP

MultiCoupling spare parts (couplings not included)

Code	Name
806000376	MULTI FIX EMPTY GR3 2B-1C-2EC
806000377	MULTI MOBILE EMPTY GR3 2B-1C-2EC
815606248	CAP FIX MULTICOUPLING GR 139x90
815606249	PARKING STATION MOBILE MULTICOUPLING GR 140x100
815701052	SPARE KIT LEVER GROUP GR 200x176

Custom configurations available upon request

Fixed and mobile multicoupling

3,7 Kg and 1,7 Kg

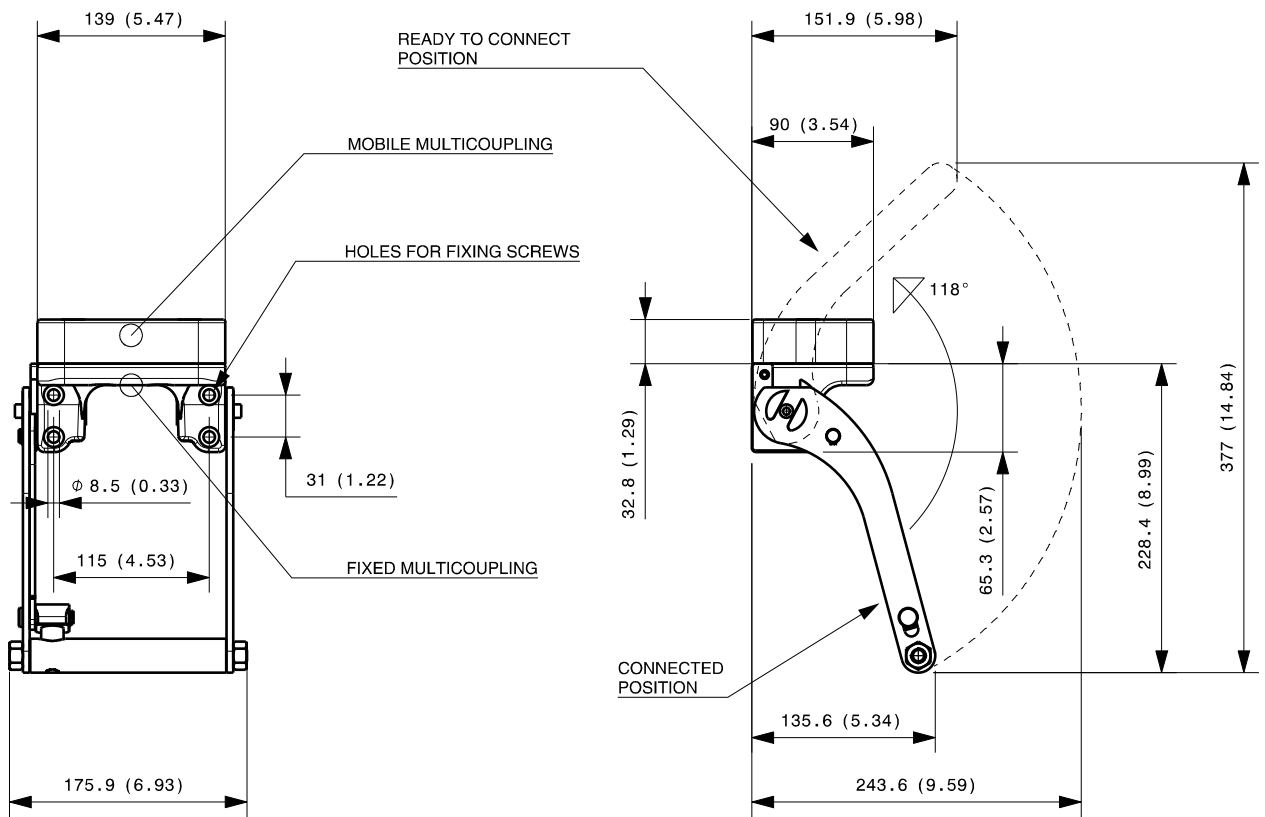

Dimensions in millimeters (inch)

Cap for fixed multicoupling 0,6 Kg

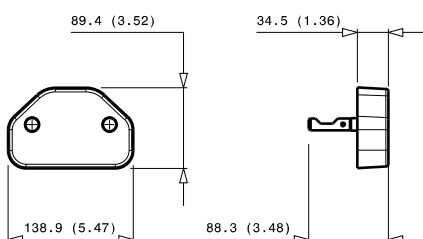

Parking station for mobile multicoupling 1,1 Kg

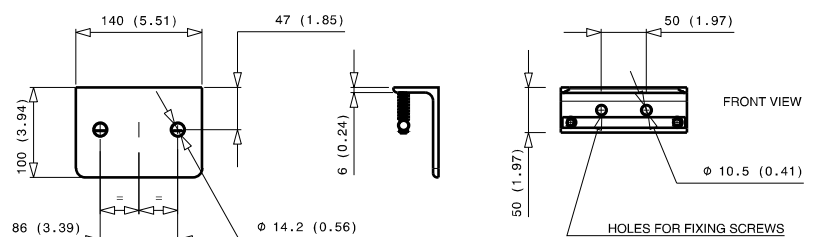

GR4 2A-1B-1C-2EC

Previous description	Max. Resistance	FAP9 (A)	FAP13 (B)	FAP15 (C)	FAP17 (D)	FAP21 (E)	FAP30 (G)
Body size		3/8"	1/2"	5/8"	3/4"	1"	1-1/2"
GRI4SBZN	18000 N	2 D	1	1			



DRAWING

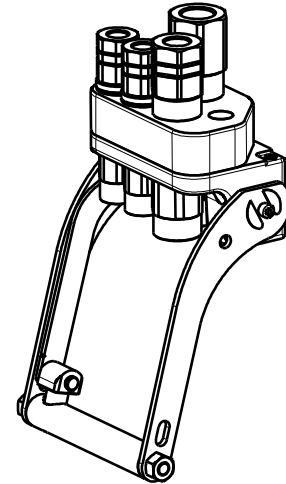

CONFIGURATIONS

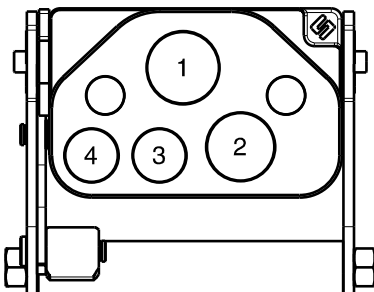

Possible configurations		
Pos	Coupling size	Predisposition for electrical connector
1	FAP15ZN	-
2	FAP13ZN	-
3	FAP9DZN	YES
4	FAP9DZN	YES

MultiCoupling (couplings included)

Code	Name	Description
870015091	MULTI COMPLETE GR4 1B-1C	1 FAP13 1/2 BSP - 1 FAP15 3/4 BSP - CAP
870015191	MULTI FIX GR4 1B-1C	1 FAP13 1/2 BSP - 1 FAP15 3/4 BSP
870015291	MULTI MOBILE GR4 1B-1C	1 FAP13 1/2 BSP - 1 FAP15 3/4 BSP

MultiCoupling spare parts (couplings not included)

Code	Name
806000276	MULTI FIX EMPTY GR4 2A-1B-1C-2EC
806000277	MULTI MOBILE EMPTY GR4 2A-1B-1C-2EC
815606246	CAP FIX MULTICOUPLING GR 139x90 V02
815606249	PARKING STATION MOBILE MULTICOUPLING GR 140x100
815701052	SPARE KIT LEVER GROUP GR 200x176

Custom configurations available upon request

Fixed and mobile multicoupling

3,7 Kg and 1,7 Kg

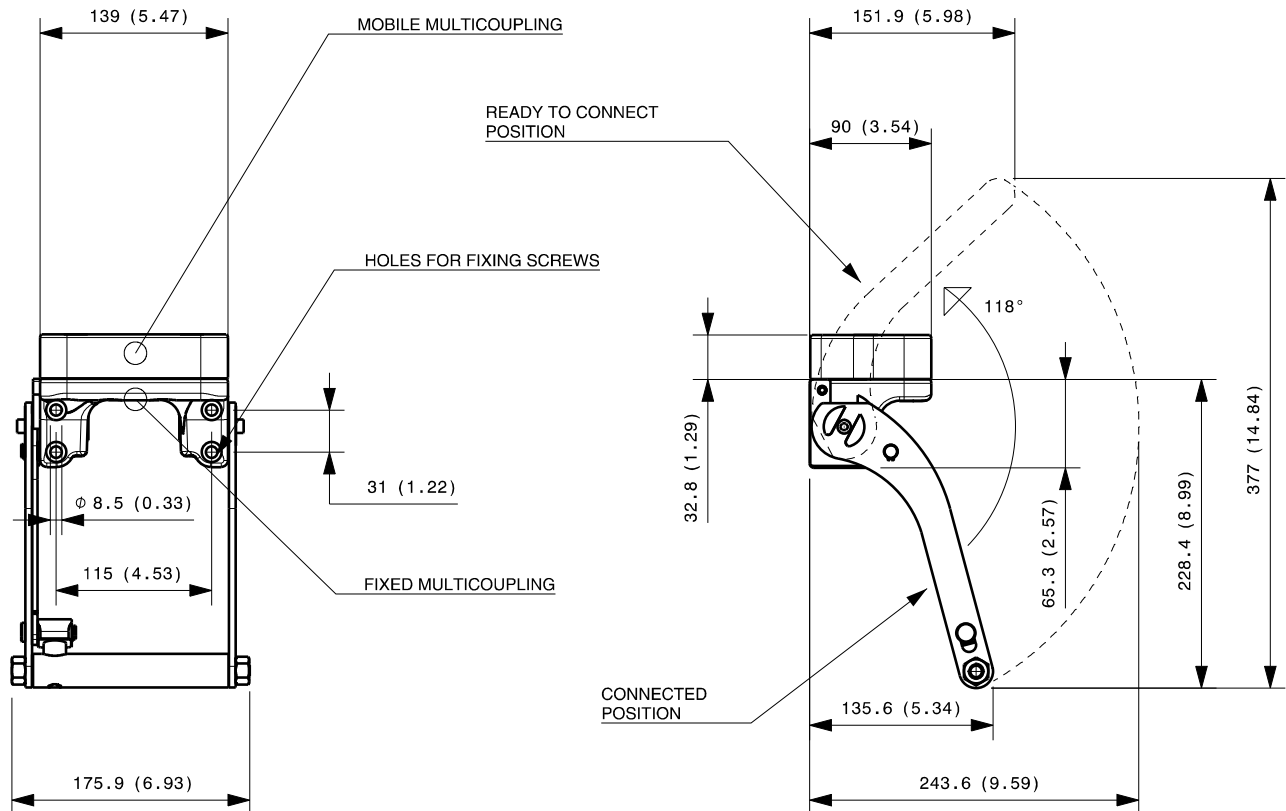

Dimensions in millimeters (inch)

Cap for fixed multicoupling 0,6 Kg

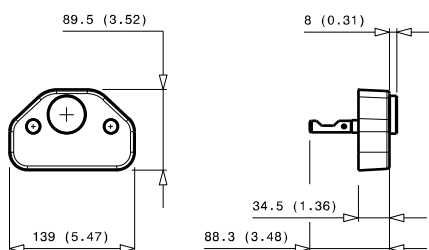

Parking station for mobile multicoupling 1,1 Kg

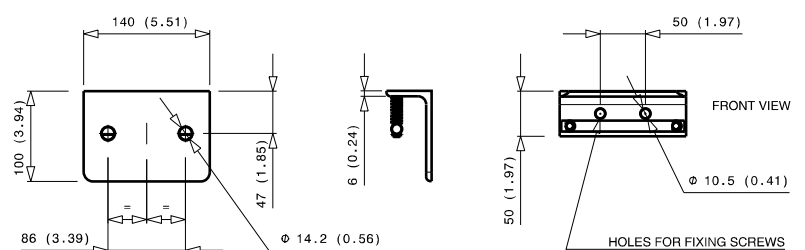

GR4 2A-2B-2EC

Previous description	Max. Resistance	FAP9 (A)	FAP13 (B)	FAP15 (C)	FAP17 (D)	FAP21 (E)	FAP30 (G)
Body size		3/8"	1/2"	5/8"	3/4"	1"	1-1/2"
GRB4ZN	18000 N	2 D	2				



DRAWING

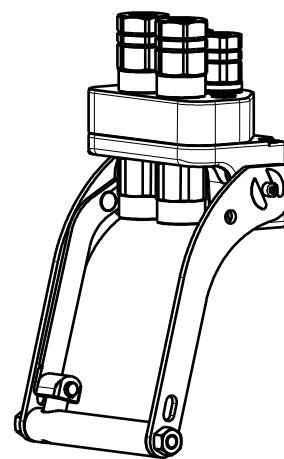

CONFIGURATIONS

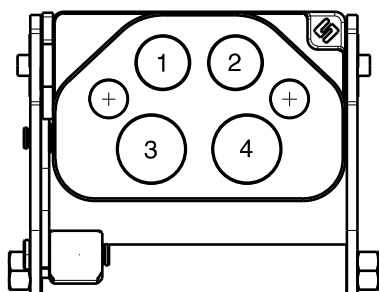

Possible configurations		
Pos	Coupling size	Predisposition for electrical connector
1	FAP9DZN	YES
2	FAP9DZN	YES
3	FAP13ZN	-
4	FAP13ZN	-

MultiCoupling (couplings included)		
Code	Name	Description
870016014	MULTI COMPLETE GR4 2A-2B	2 FAP9D 3/8 BSP - 2 FAP13 1/2 BSP - CAP
870016073	MULTI COMPLETE GR4 2A-1B	2 FAP9D 3/8 NPT - 1 FAP13 1/2 NPT - CAP
870016081	MULTI COMPLETE GR4 2B-2EC	1 FAP13 1/2 BSP - 1 FAQ13 1/2 BSP - 2EC7 - CAP
870016114	MULTI FIX GR4 2A-2B	2 FAP9D 3/8 BSP - 2 FAP13 1/2 BSP
870016214	MULTI MOBILE GR4 2A-2B	2 FAP9D 3/8 BSP - 2 FAP13 1/2 BSP

MultiCoupling spare parts (couplings not included)	
Code	Name
806000274	MULTI FIX EMPTY GR4 2A-2B-2EC
806000275	MULTI MOBILE EMPTY GR4 2A-2B-2EC
815606248	CAP FIX MULTICOUPLING GR 139x90
815606249	PARKING STATION MOBILE MULTICOUPLING GR 140x100
815701052	SPARE KIT LEVER GROUP GR 200x176

Custom configurations available upon request

Fixed and mobile multicoupling

3,7 Kg and 1,8 Kg

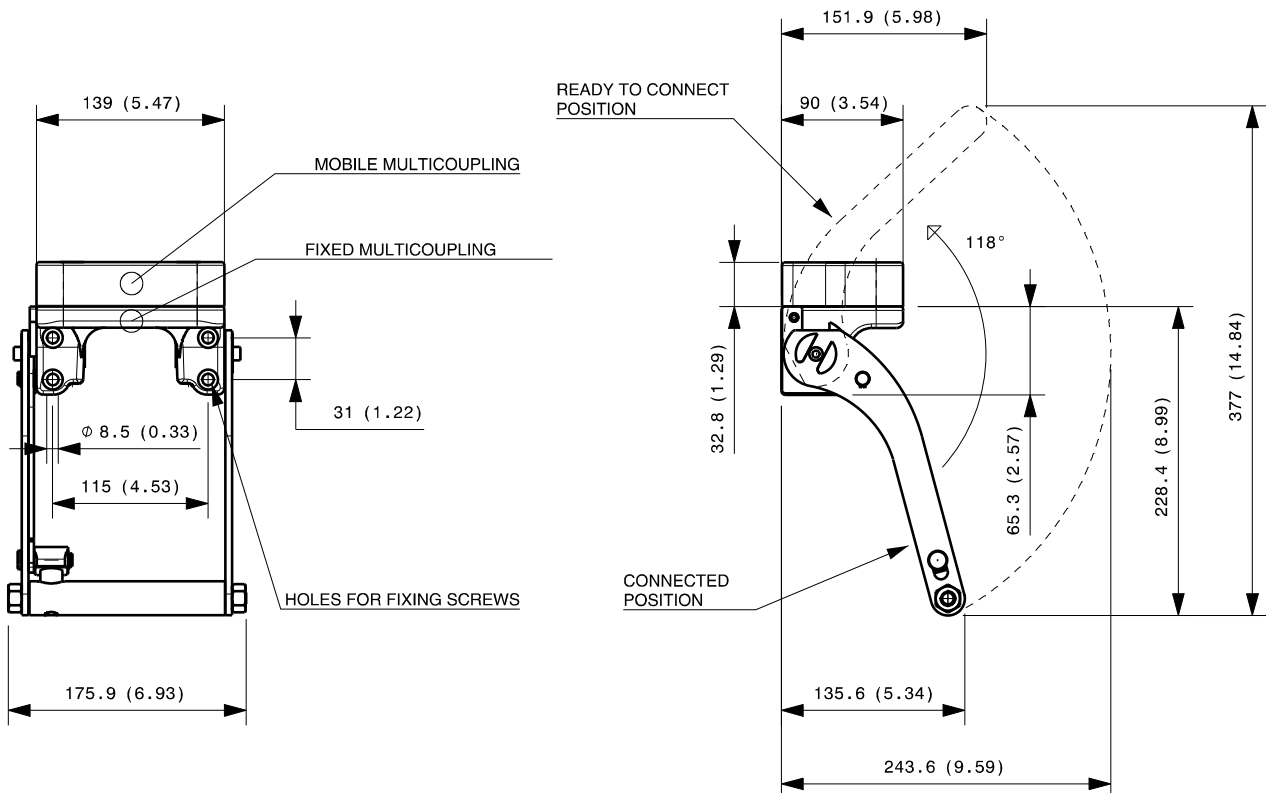

Dimensions in millimeters (inch)

Cap for fixed multicoupling 0,6 Kg

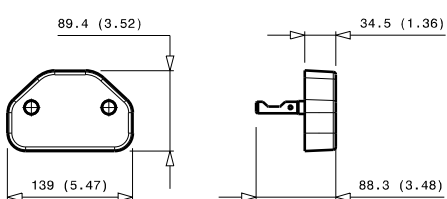

Parking station for mobile multicoupling 1,1 Kg

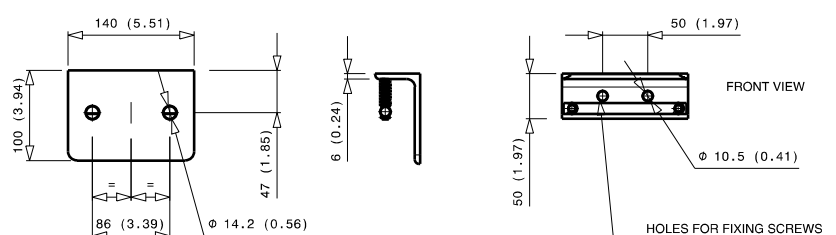

GR4 2A-1B-1D-2EC

Previous description	Max. Resistance	FAP9 (A)		FAP13 (B)	FAP15 (C)	FAP17 (D)	FAP21 (E)	FAP30 (G)
Body size		3/8"	D	1/2"	5/8"	3/4"	1"	1-1/2"
GR4MRZN	18000 N	2	D	1		1		



DRAWING

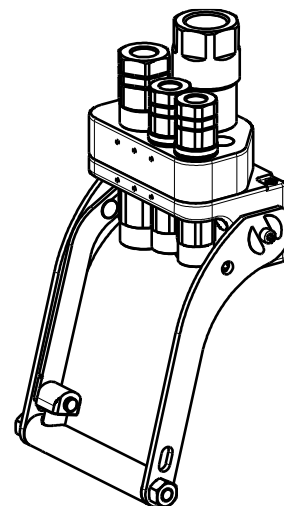

CONFIGURATIONS

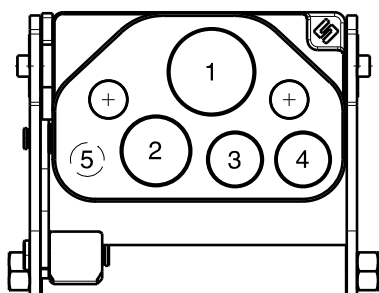

Possible configurations		
Pos	Coupling size	Predisposition for electrical connector
1	FAP17ZN	-
2	FAP13ZN	-
3	FAP9DZN	YES
4	FAP9DZN	YES
5		*

* - Holes Ø16 (0.63) for optional sensor.

MultiCoupling (couplings included)

Code	Name	Description
870016015	MULTI COMPLETE GR4 2A-1B-1D	2 FAP9D 3/8 BSP - 1 FAP13 1/2 BSP - 1 FAP17 1 BSP - CAP
870016115	MULTI FIX GR4 2A-1B-1D	2 FAP9D 3/8 BSP - 1 FAP13 1/2 BSP - 1 FAP17 1 BSP
870016215	MULTI MOBILE GR4 2A-1B-1D	2 FAP9D 3/8 BSP - 1 FAP13 1/2 BSP - 1 FAP17 1 BSP

MultiCoupling spare parts (couplings not included)

Code	Name
806000280	MULTI FIX EMPTY GR4 2A-1B-1D-2EC
806000281	MULTI MOBILE EMPTY GR4 2A-1B-1D-2EC
815606244	CAP FIX MULTICOUPLING GR 139x90 V01
815606249	PARKING STATION MOBILE MULTICOUPLING GR 140x100
815701052	SPARE KIT LEVER GROUP GR 200x176
815701300	KIT PLUG FOR HOLE D16 MULTI FIX GR4 2A-1B-1D-2EC

Custom configurations available upon request

Fixed and mobile multicoupling

3,6 Kg and 1,7 Kg

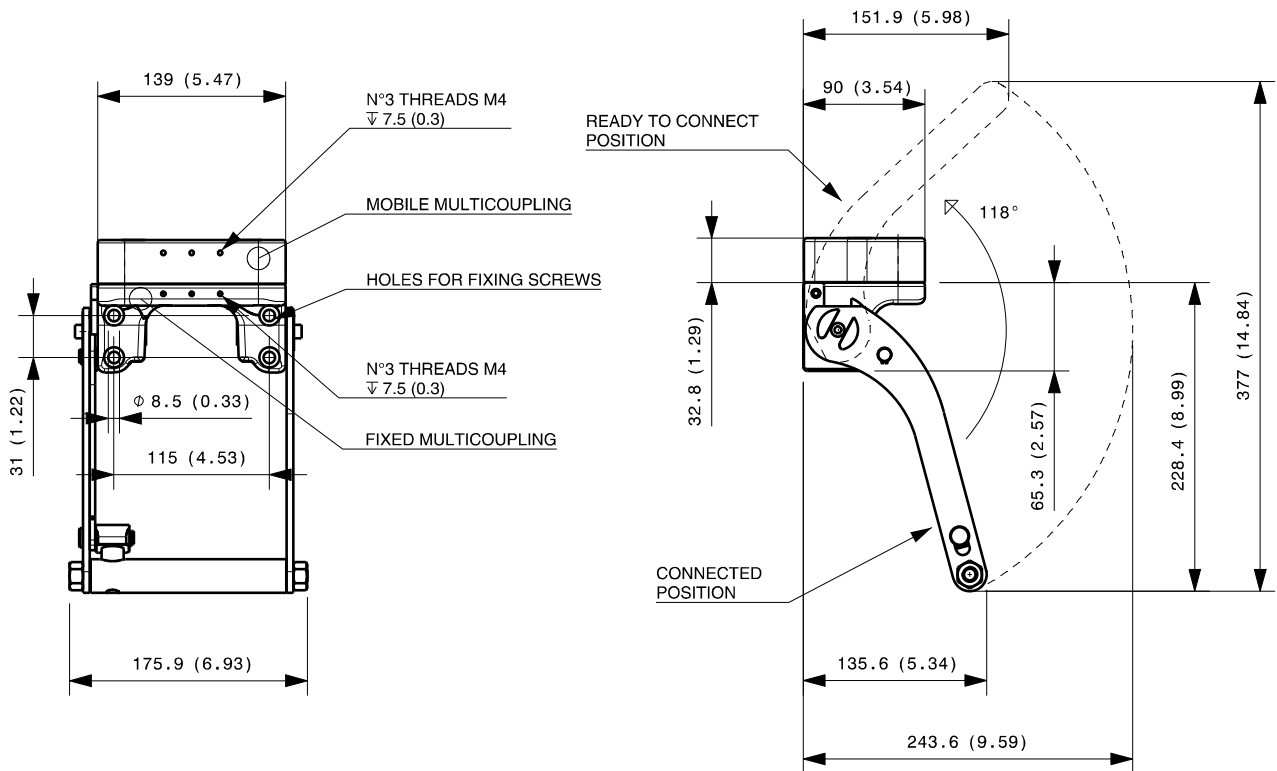

Dimensions in millimeters (inch)

Cap for fixed multicoupling 0,6 Kg

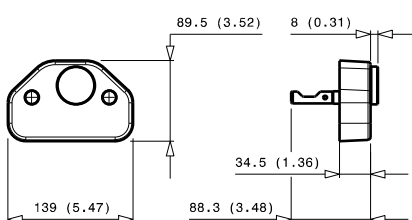

Parking station for mobile multicoupling 1,1 Kg

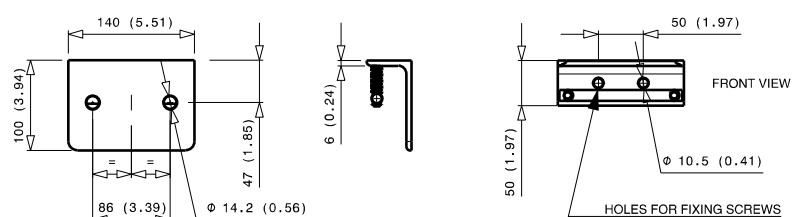

GR4 2A-1C-1D-2EC

Previous description	Max. Resistance	FAP9 (A)	FAP13 (B)	FAP15 (C)	FAP17 (D)	FAP21 (E)	FAP30 (G)
Body size		3/8"	1/2"	5/8"	3/4"	1"	1-1/2"
GRI4ZN	18000 N	2	D	1	1		



DRAWING

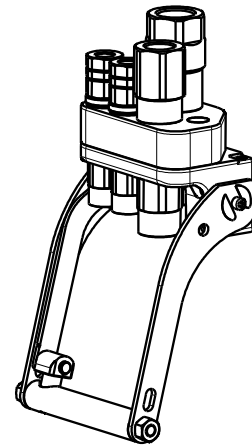

CONFIGURATIONS

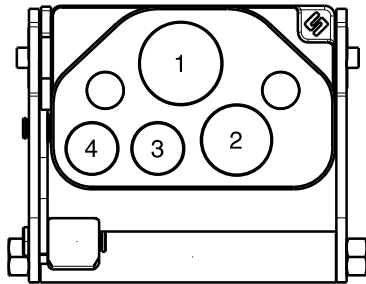

Possible configurations		
Pos	Coupling size	Predisposition for electrical connector
1	FAP17ZN	-
2	FAP15ZN	-
3	FAP9DZN	YES
4	FAP9DZN	YES

MultiCoupling (couplings included)		
Code	Name	Description
870015058	MULTI COMPLETE GR4 2A-1C-1D	2 FAP9D 3/8 BSP - 1 FAP15 3/4 BSP - 1 FAP17 1 BSP - CAP
870015060	MULTI COMPLETE GR4 1A-1C-1D	1 FAP9D 3/8 BSP - 1 FAP15 3/4 BSP - 1 FAP17 1 BSP - CAP
870015074	MULTI COMPLETE GR4 1C-1D	1 FAP15 3/4 BSP - 1 FAP17 1 BSP - CAP
870015086	MULTI COMPLETE GR4 1C-1D-2EC	1 FAP15 3/4 BSP - 1 FAP17 1 BSP - 2EC6 - CAP
870016025	MULTI COMPLETE GR4 1D-1EC	1 FAP17 3/4 BSP - 1EC6 - CAP
870016026	MULTI COMPLETE GR4 2A-1D	2 FAP9D 1/2 BSP - 1 FAP17 1 BSP - CAP
870015095	MULTI COMPLETE GR4 2A-1C	2 FAP9D 3/8 BSP - 1 FAP15 3/4 BSP - CAP
870015158	MULTI FIX GR4 2A-1C-1D	2 FAP9D 3/8 BSP - 1 FAP15 3/4 BSP - 1 FAP17 1 BSP
870015160	MULTI FIX GR4 1A-1C-1D	1 FAP9D 3/8 BSP - 1 FAP15 3/4 BSP - 1 FAP17 1 BSP
870016126	MULTI FIX GR4 2A-1D	2 FAP9D 1/2 BSP - 1 FAP17 1 BSP
870016127	MULTI FIX GR4 1A-1C-1D	1 FAP9D 3/8 BSP - 1 FAP15 3/4 BSP - 1 FAP17 3/4 BSP
870015258	MULTI MOBILE GR4 2A-1C-1D	2 FAP9D 3/8 BSP - 1 FAP15 3/4 BSP - 1 FAP17 1 BSP
870015260	MULTI MOBILE GR4 1A-1C-1D	1 FAP9D 3/8 BSP - 1 FAP15 3/4 BSP - 1 FAP17 1 BSP
870016225	MULTI MOBILE GR4 1D-1EC	1 FAP17 3/4 BSP - 1EC6
870016226	MULTI MOBILE GR4 2A-1D	2 FAP9D 1/2 BSP - 1 FAP17 1 BSP
870016227	MULTI MOBILE GR4 1A-1C-1D	1 FAP9D 3/8 BSP - 1 FAP15 3/4 BSP - 1 FAP17 3/4 BSP

MultiCoupling spare parts (couplings not included)	
Code	Name
806000282	MULTI FIX EMPTY GR4 2A-1C-1D-2EC
806000283	MULTI MOBILE EMPTY GR4 2A-1C-1D-2EC
815606246	CAP FIX MULTICOUPLING GR 139x90 V02
815606249	PARKING STATION MOBILE MULTICOUPLING GR 140x100
815701052	SPARE KIT LEVER GROUP GR 200x176

Custom configurations available upon request

Fixed and mobile multicoupling

3,6 Kg and 1,7 Kg

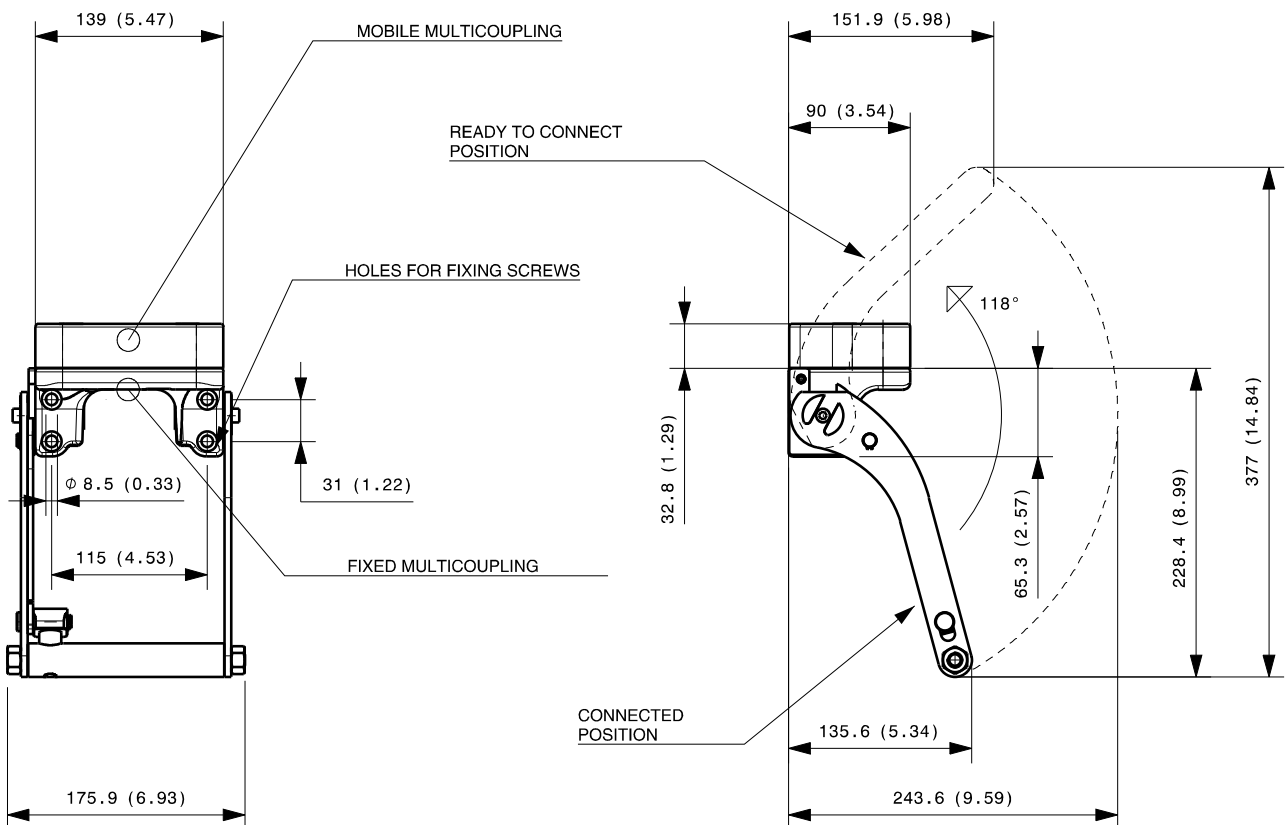

Dimensions in millimeters (inch)

Cap for fixed multicoupling 0,6 Kg

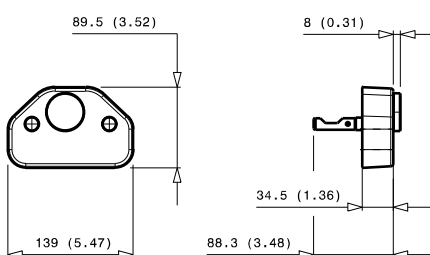

Parking station for mobile multicoupling 1,1 Kg

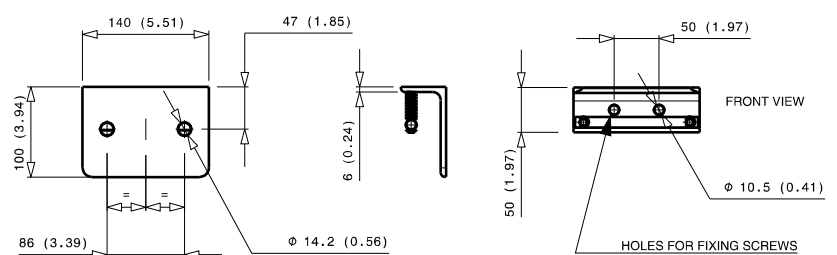

GR4 2A-2C-2EC

Previous description	Max. Resistance	FAP9 (A)	FAP13 (B)	FAP15 (C)	FAP17 (D)	FAP21 (E)	FAP30 (G)
Body size		3/8"	1/2"	5/8"	3/4"	1"	1-1/2"
GRI4TBZN	18000 N	2	D	2			



DRAWING



CONFIGURATIONS

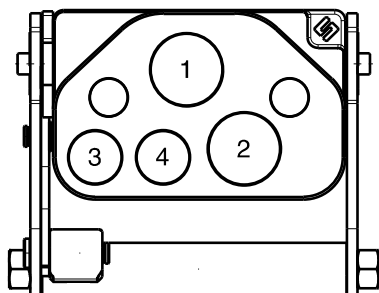

Possible configurations		
Pos	Coupling size	Predisposition for electrical connector
1	FAP15ZN	-
2	FAP15ZN	-
3	FAP9DZN	YES
4	FAP9DZN	YES

MultiCoupling (couplings included)		
Code	Name	Description
870016008	MULTI COMPLETE GR4 1A-2C-1EC	1 FAP9D 1/2 BSP - 2 FAP15 3/4 BSP - 1EC7 - CAP
870016041	MULTI COMPLETE GR4 1A-2C	1 FAP9D 3/8 NPT - 2 FAP15 3/4 NPT - CAP
870016060	MULTI COMPLETE GR4 1A-2C	1 FAP9D 3/8 SAE - 2 FAP15 3/4 SAE - CAP
870016108	MULTI FIX GR4 1A-2C-1EC	1 FAP9D 1/2 BSP - 2 FAP15 3/4 BSP - 1EC7
870016111	MULTI FIX GR4 1A-2C	1 FAP9D 3/8 BSP - 2 FAP15 3/4 BSP
870016129	MULTI FIX GR4 1A-2C-1EC	1 FAP9D 3/8 BSP - 2 FAP15 3/4 BSP - 1EC7
870016208	MULTI MOBILE GR4 1A-2C-1EC	1 FAP9D 1/2 BSP - 2 FAP15 3/4 BSP - 1EC7
870016211	MULTI MOBILE GR4 1A-2C	1 FAP9D 3/8 BSP - 2 FAP15 3/4 BSP
870016229	MULTI MOBILE GR4 1A-2C-1EC	1 FAP9D 3/8 BSP - 2 FAP15 3/4 BSP - 1EC7
870016241	MULTI MOBILE GR4 1A-2C	1 FAP9D 3/8 NPT - 2 FAP15 3/4 NPT
870016260	MULTI MOBILE GR4 1A-2C	1 FAP9D 3/8 SAE - 2 FAP15 3/4 SAE

MultiCoupling spare parts (couplings not included)		
Code	Name	
806000278	MULTI FIX EMPTY GR4 2A-2C-2EC	
806000279	MULTI MOBILE EMPTY GR4 2A-2C-2EC	
815606246	CAP FIX MULTICOUPLING GR 139x90 V02	
815606249	PARKING STATION MOBILE MULTICOUPLING GR 140x100	
815701052	SPARE KIT LEVER GROUP GR 200x176	

Custom configurations available upon request

Fixed and mobile multicoupling

3,7 Kg and 1,7 Kg

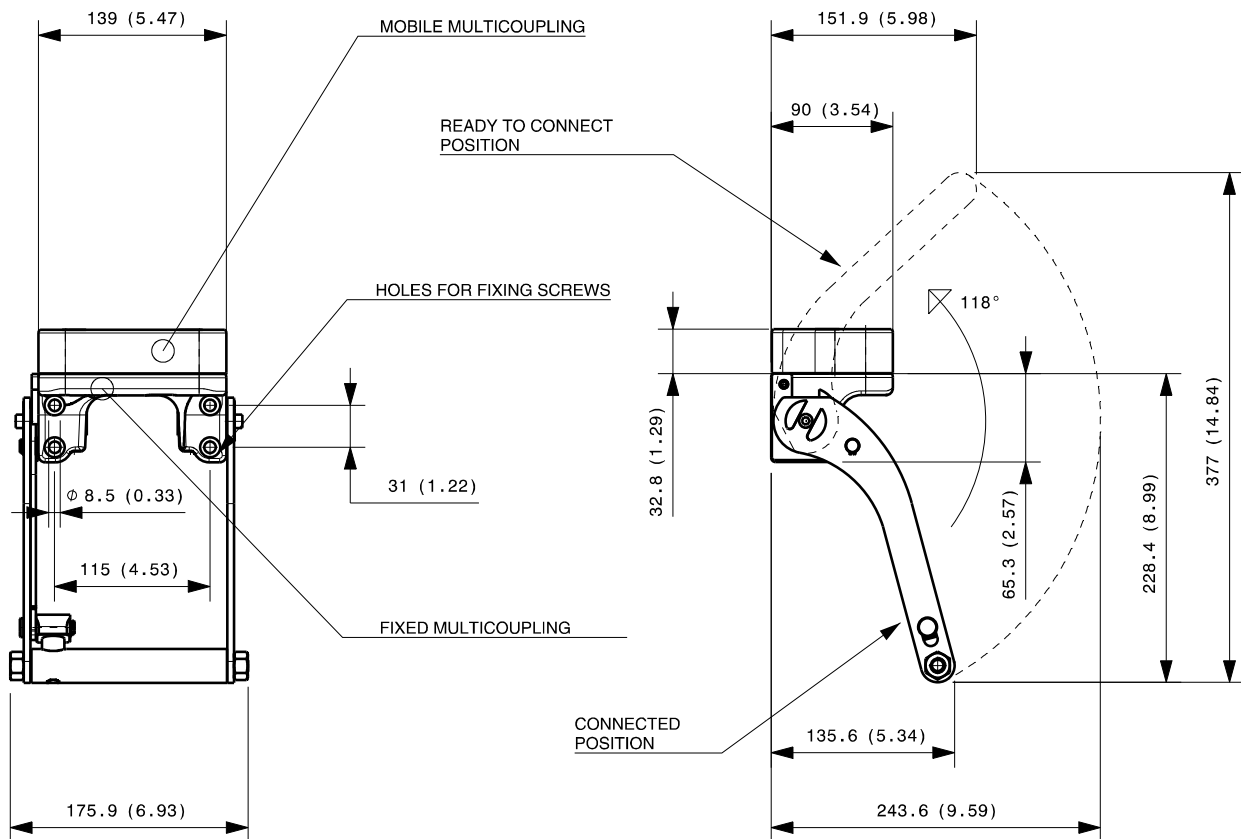

Dimensions in millimeters (inch)

Cap for fixed multicoupling 0,6 Kg

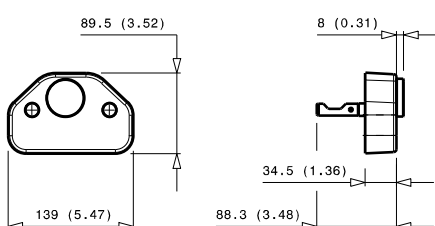

Parking station for mobile multicoupling 1,1 Kg

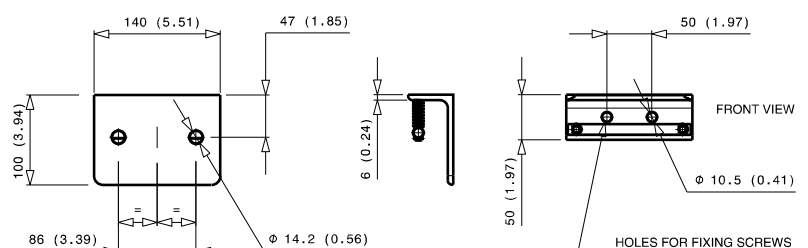

GR5 1A-1B-1C-2D-1EC

Previous description	Max. Resistance	FAP9 (A)	FAP13 (B)	FAP15 (C)	FAP17 (D)	FAP21 (E)	FAP30 (G)
Body size		3/8"	1/2"	5/8"	3/4"	1"	1-1/2"
GRP6ZN	23000 N	1 D	1	1	2		



DRAWING

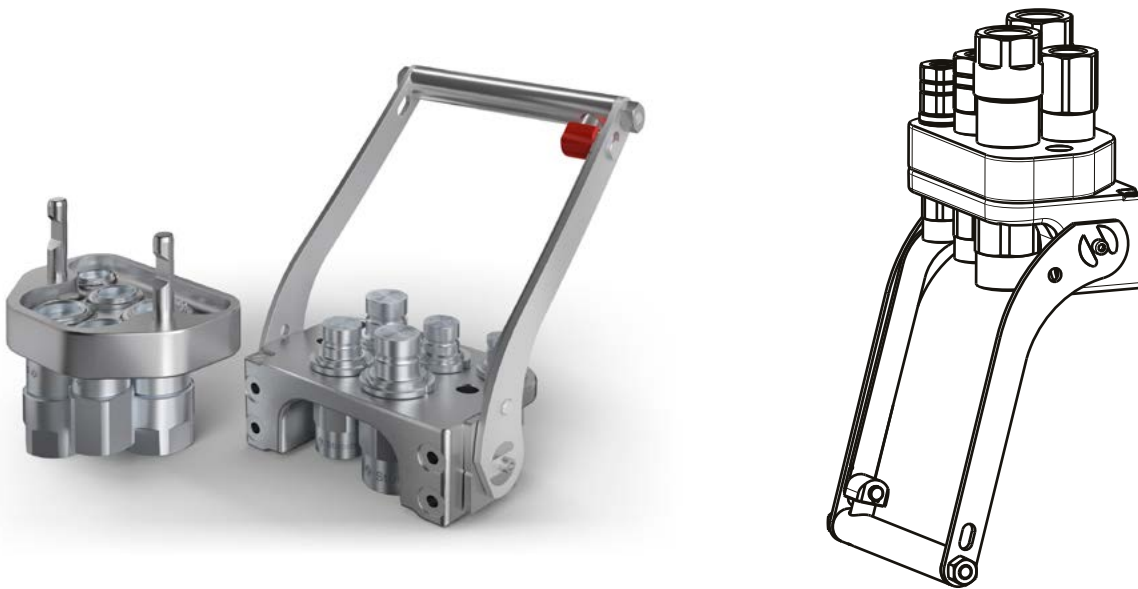

CONFIGURATIONS

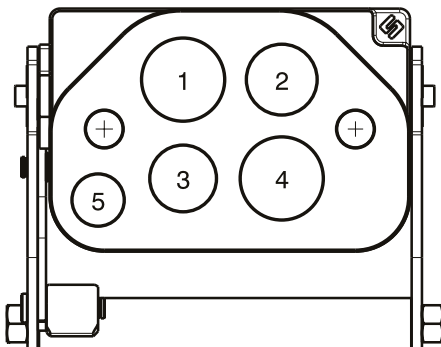

Possible configurations		
Pos	Coupling size	Predisposition for electrical connector
1	FAP17ZN	-
2	FAP15ZN	-
3	FAP13ZN	-
4	FAP17ZN	-
5	FAP9DZN	YES

MultiCoupling (couplings included)

Code	Name	Description
870016061	MULTI COMPLETE GR5 1A-1B-1C-2D	1 FAP9D 3/8 BSP - 1 FAP13 1/2 BSP - 1 FAP15 3/4 BSP - 2 FAP17 1 BSP - CAP
870016161	MULTI FIX GR5 1A-1B-1C-2D	1 FAP9D 3/8 BSP - 1 FAP13 1/2 BSP - 1 FAP15 3/4 BSP - 2 FAP17 1 BSP
870016261	MULTI MOBILE GR5 1A-1B-1C-2D	1 FAP9D 3/8 BSP - 1 FAP13 1/2 BSP - 1 FAP15 3/4 BSP - 2 FAP17 1 BSP

MultiCoupling spare parts (couplings not included)

Code	Name
806000432	MULTI FIX EMPTY GR5 1A-1B-1C-2D-1EC
806000433	MULTI MOBILE EMPTY GR5 1A-1B-1C-2D-1EC
815606258	CAP FIX MULTICOUPLING GR 175x117 V01
815606259	PARKING STATION MOBILE MULTICOUPLING GR 180x120 V01
815700999	SPARE KIT LEVER GROUP GR 250x212

Custom configurations available upon request

Fixed and mobile multicoupling

5,7 Kg and 2,7 Kg

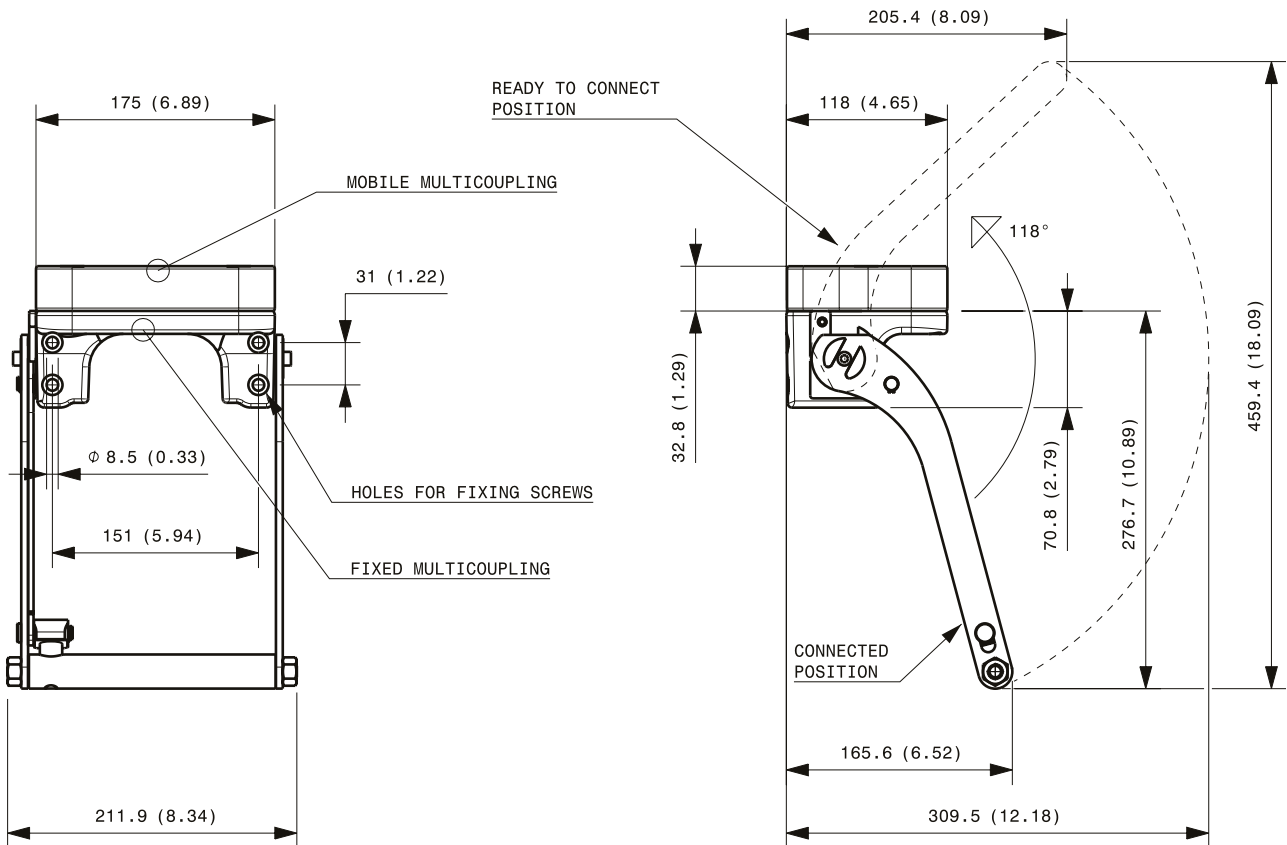

Dimensions in millimeters (inch)

Cap for fixed multicoupling 1,1 Kg

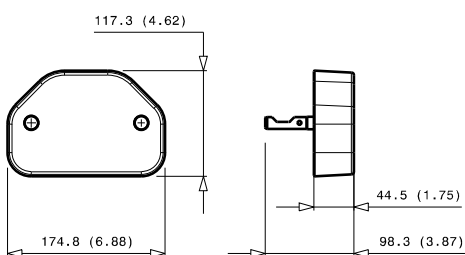

Parking station for mobile multicoupling 2,3 Kg

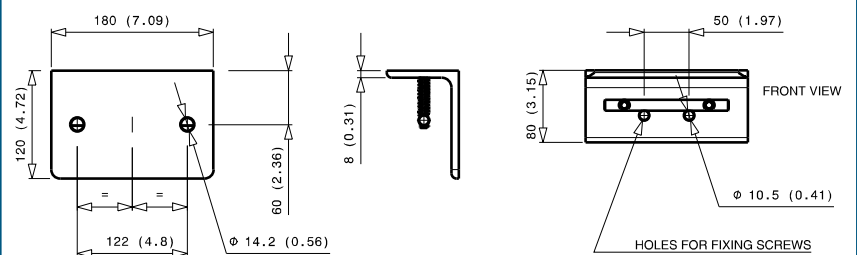

GR5 2B-3D-2EC

Previous description	Max. Resistance	FAP9 (A)	FAP13 (B)	FAP15 (C)	FAP17 (D)	FAP21 (E)	FAP30 (G)
Body size		3/8"	1/2"	5/8"	3/4"	1"	1-1/2"
GR5AAZN	23000 N		2		3		



DRAWING



CONFIGURATIONS

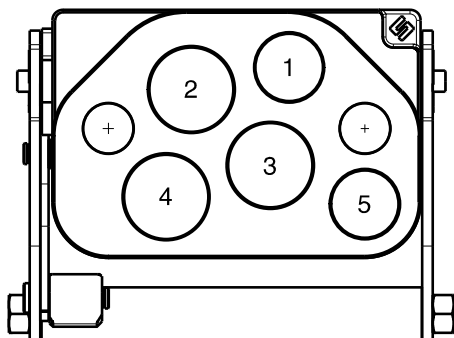

Possible configurations		
Pos	Coupling size	Predisposition for electrical connector
1	FAP13ZN	YES
2	FAP17ZN	-
3	FAP17ZN	-
4	FAP17ZN	-
5	FAP13ZN	YES

MultiCoupling (couplings included)

Code	Name	Description
870015080	MULTI COMPLETE GR5 2B-3D	2 FAP13 1/2 BSP - 3 FAP17 3/4 BSP - CAP
870016033	MULTI COMPLETE GR5 2B-1D	2 FAP13 3/4 BSP - 1 FAP17 1 BSP - CAP
870016046	MULTI COMPLETE GR5 1B-3D	1 FAP13 3/4 BSP - 3 FAP17 1 BSP - CAP
870016072	MULTI COMPLETE GR5 1B-2D	1 FAP13 1/2 NPT - 1 FAP17 3/4 NPT - 1 FAP17 1 NPT - CAP
870016074	MULTI COMPLETE GR5 1B-3D	1 FAP13 1/2 NPT - 2 FAP17 3/4 NPT - 1 FAP17 1 NPT - CAP
870015180	MULTI FIX GR5 2B-3D	2 FAP13 1/2 BSP - 3 FAP17 3/4 BSP
870016122	MULTI FIX GR5 3D-2EC	3 FAP17 1 BSP - 2 EC6
870016147	MULTI FIX GR5 3D	3 FAP17 3/4 BSP
870016154	MULTI FIX GR5 1B-3D	1 FAP13 1/2 BSP - 3 FAP17 3/4 BSP
870016153	MULTI FIX GR5 3D	3 FAP17 1 BSP
870016184	MULTI FIX GR5 3D-2EC	3 FAP17 3/4 BSP - 2 EC6
870016246	MULTI MOBILE GR5 1B-3D	1 FAP13 3/4 BSP - 3 FAP17 1 BSP
870015280	MULTI MOBILE GR5 2B-3D	2 FAP13 1/2 BSP - 3 FAP17 3/4 BSP
870016222	MULTI MOBILE GR5 3D-2EC	3 FAP17 1 BSP - 2 EC6
870016247	MULTI MOBILE GR5 3D	3 FAP17 3/4 BSP
870016254	MULTI MOBILE GR5 1B-3D	1 FAP13 1/2 BSP - 3 FAP17 3/4 BSP
870016253	MULTI MOBILE GR5 3D	3 FAP17 1 BSP
870016284	MULTI MOBILE GR5 3D-2EC	3 FAP17 3/4 BSP - 2 EC6

MultiCoupling spare parts (couplings not included)

Code	Name
806000312	MULTI FIX EMPTY GR5 2B-3D-2EC
806000313	MULTI MOBILE EMPTY GR5 2B-3D-2EC
815606260	CAP FIX MULTICOUPLING GR 175x117 V02
815606261	PARKING STATION MOBILE MULTICOUPLING GR 180x120 V02
815701055	SPARE KIT LEVER GROUP GR 250x212

Custom configurations available upon request

Fixed and mobile multicoupling

5,5 Kg and 2,7 Kg

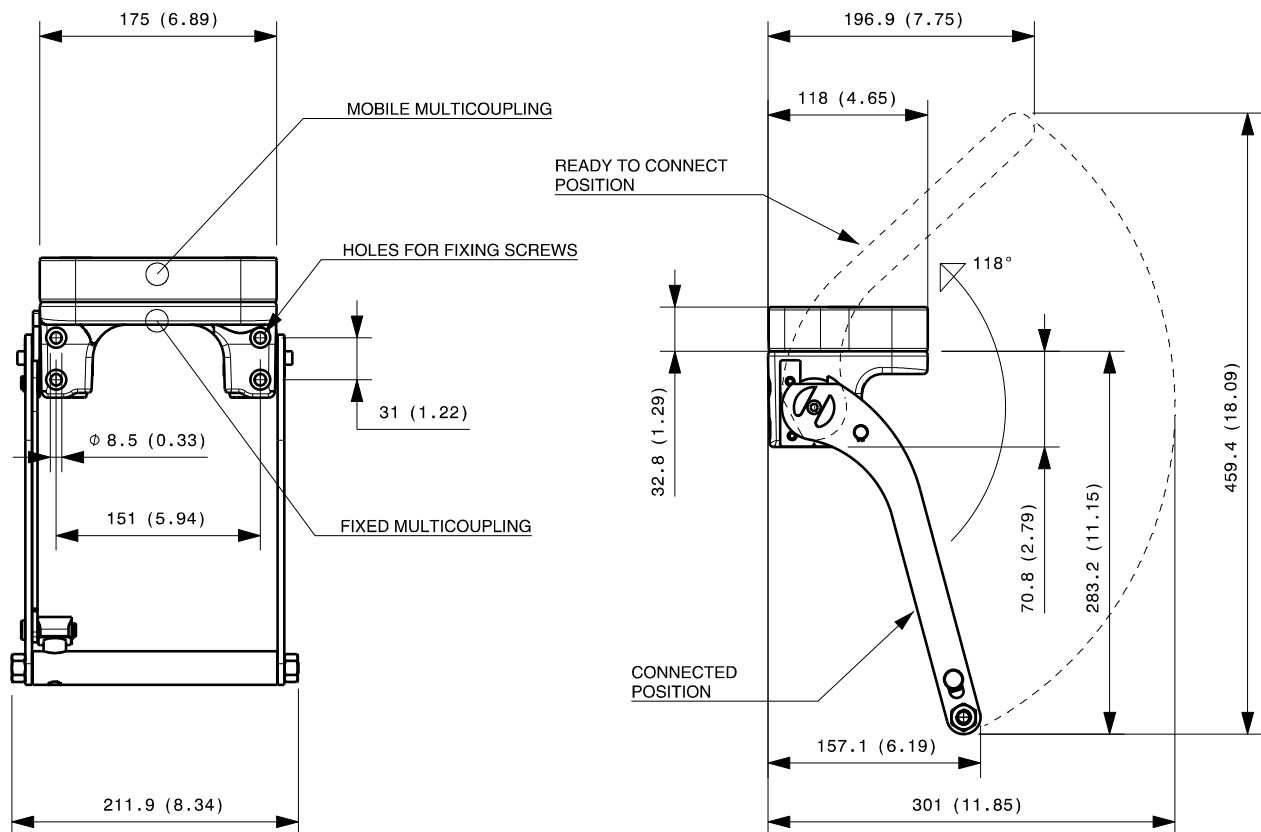

Dimensions in millimeters (inch)

Cap for fixed multicoupling 1,2 Kg

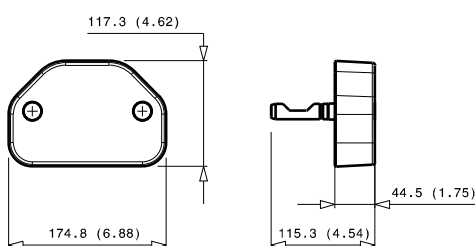

Parking station for mobile multicoupling 2,4 Kg

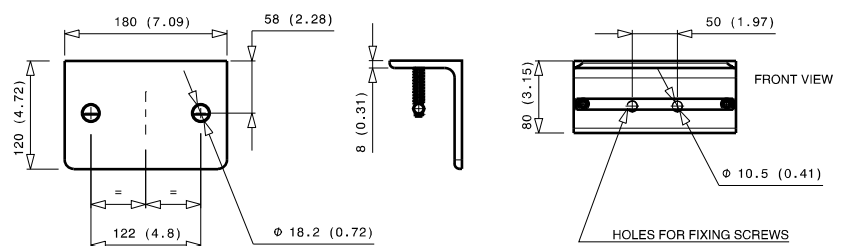

GR5 3A-1D-1E-2EC

Previous description	Max. Resistance	FAP9 (A)	FAP13 (B)	FAP15 (C)	FAP17 (D)	FAP21 (E)	FAP30 (G)
Body size		3/8"	1/2"	5/8"	3/4"	1"	1-1/2"
GRD5ZN	23000 N	3	D		1	1	



DRAWING

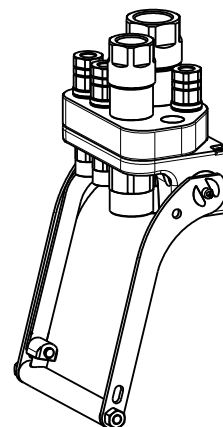

CONFIGURATIONS

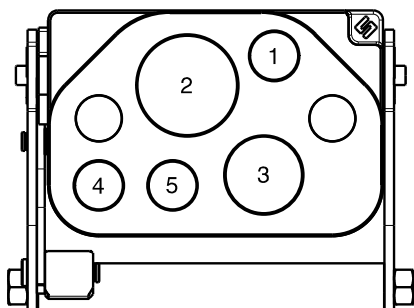

Possible configurations		
Pos	Coupling size	Predisposition for electrical connector
1	FAP9DZN	-
2	FAP21ZN	-
3	FAP17ZN	-
4	FAP9DZN	YES
5	FAP9DZN	YES

MultiCoupling (couplings included)

Code	Name	Description
870015066	MULTI COMPLETE GR5 2A-1D-1E	2 FAP9D 3/8 BSP - 1 FAP17 1 BSP - 1 FAP21 1-1/4 BSP - CAP
870015079	MULTI COMPLETE GR5 1A-1D-1E-1EC	1 FAP9D 3/8 BSP - 1 FAP17 3/4 BSP - 1 FAP21 1 BSP - 1EC6 - CAP
870015084	MULTI COMPLETE GR5 1D-1E-2EC	1 FAP17 3/4 BSP - 1 FAP21 1 BSP - 2EC6 - CAP
870015099	MULTI COMPLETE GR5 2A-1D-1E	2 FAP9D 3/8 BSP - 1 FAP17 3/4 BSP - 1 FAP21 1 BSP - CAP
870016000	MULTI COMPLETE GR5 3A-1D-1E	3 FAP9D 1/2 BSP - 1 FAP17 1 BSP - 1 FAP21 1-1/4 BSP - CAP
870016030	MULTI COMPLETE GR5 2A-1D-1E-1EC6	1 FAP9D 3/8 BSP - 1 FAP9D 1/2 BSP - 1 FAP17 1 BSP - 1 FAP21 1-1/4 BSP - 1EC6 - CAP
870016042	MULTI COMPLETE GR5 1A-1D-1E	1 FAP9D 3/8 BSP - 1 FAP17 1 BSP - 1 FAP21 1-1/4 BSP - CAP
870016043	MULTI COMPLETE GR5 2A-1E	2 FAP9D 3/8 BSP - 1 FAP21 1-1/4 BSP - CAP
870015161	MULTI FIX GR5 2A-1D-1E	2 FAP9D 1/2 BSP - 1 FAP17 1 BSP - 1 FAP21 1-1/4 BSP
870015184	MULTI FIX GR5 1D-1E-2EC	1 FAP17 3/4 BSP - 1 FAP21 1 BSP - 2EC6
870015166	MULTI FIX GR5 2A-1D-1E	2 FAP9D 3/8 BSP - 1 FAP17 1 BSP - 1 FAP21 1-1/4 BSP
870015199	MULTI FIX GR5 2A-1D-1E	2 FAP9D 3/8 BSP - 1 FAP17 3/4 BSP - 1 FAP21 1 BSP
870016130	MULTI FIX GR5 2A-1D-1E-1EC	1 FAP9D 3/8 BSP - 1 FAP9D 1/2 BSP - 1 FAP17 1 BSP - 1 FAP21 1-1/4 BSP - 1EC6
870016185	MULTI FIX GR5 2A-1D-1E-1EC	2 FAP9D 1/4 BSP - 1 FAP17 3/4 BSP - 1 FAP21 1-1/4 BSP - 1EC6
870015261	MULTI MOBILE GR5 2A-1D-1E	2 FAP9D 1/2 BSP - 1 FAP17 1 BSP - 1 FAP21 1-1/4 BSP
870015266	MULTI MOBILE GR5 2A-1D-1E	2 FAP9D 3/8 BSP - 1 FAP17 1 BSP - 1 FAP21 1-1/4 BSP
870015284	MULTI MOBILE GR5 1D-1E-2EC	1 FAP17 3/4 BSP - 1 FAP21 1 BSP - 2EC6
870015299	MULTI MOBILE GR5 2A-1D-1E	2 FAP9D 3/8 BSP - 1 FAP17 3/4 BSP - 1 FAP21 1 BSP
870016230	MULTI MOBILE GR5 2A-1D-1E-1EC	1 FAP9D 3/8 BSP - 1 FAP9D 1/2 BSP - 1 FAP17 1 BSP - 1 FAP21 1-1/4 BSP - 1EC6
870016285	MULTI MOBILE GR5 2A-1D-1E-1EC	2 FAP9D 1/4 BSP - 1 FAP17 3/4 BSP - 1 FAP21 1-1/4 BSP - 1EC6

MultiCoupling spare parts (couplings not included)

Code	Name
806000316	MULTI FIX EMPTY GR5 3A-1D-1E-2EC
806000317	MULTI MOBILE EMPTY GR5 3A-1D-1E-2EC
815606260	CAP FIX MULTICOUPLING GR 175x117 V02
815606261	PARKING STATION MOBILE MULTICOUPLING GR 180x120 V02
815701055	SPARE KIT LEVER GROUP GR 250x212

Custom configurations available upon request

Fixed and mobile multicoupling

5,6 Kg and 2,8 Kg

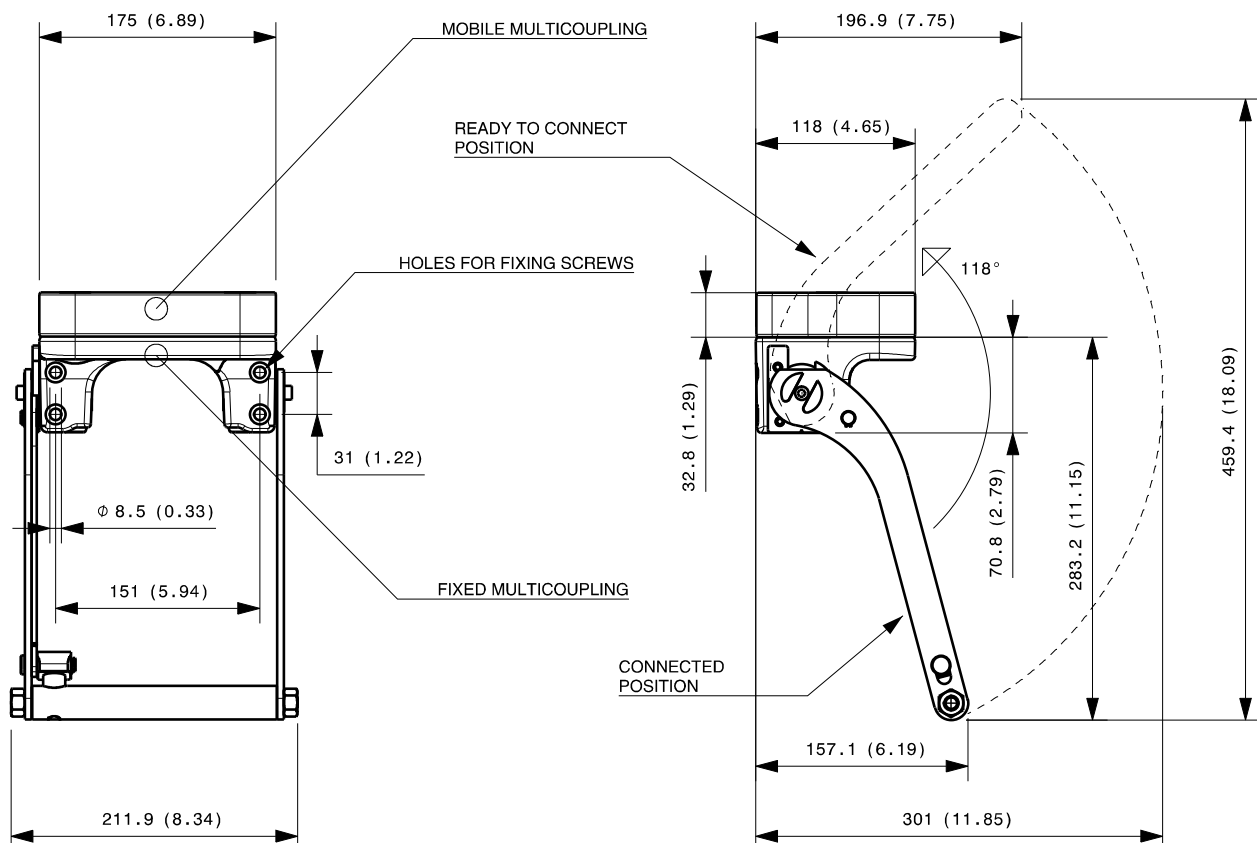

Dimensions in millimeters (inch)

Cap for fixed multicoupling 1,2 Kg

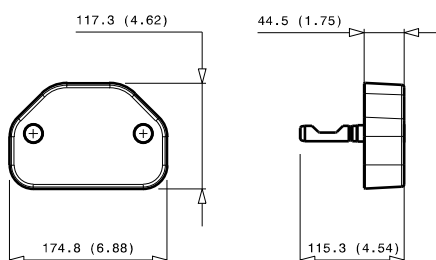

Parking station for mobile multicoupling 2,4 Kg

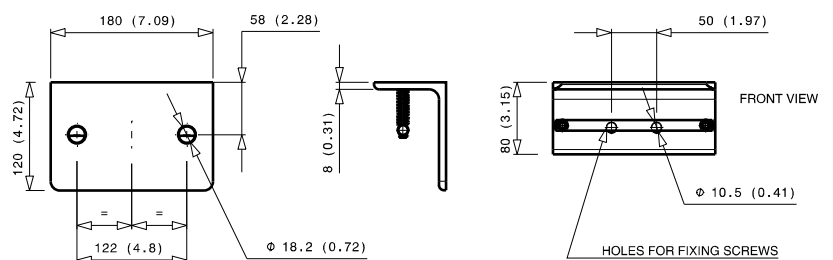

GR5 2B-2C-1E-2EC

Previous description	Max. Resistance Body size	FAP9 (A) 3/8"	FAP13 (B) 1/2"	FAP15 (C) 5/8"	FAP17 (D) 3/4"	FAP21 (E) 1"	FAP30 (G) 1-1/2"
GRZ5ZN	23000 N		2	2		1	



DRAWING

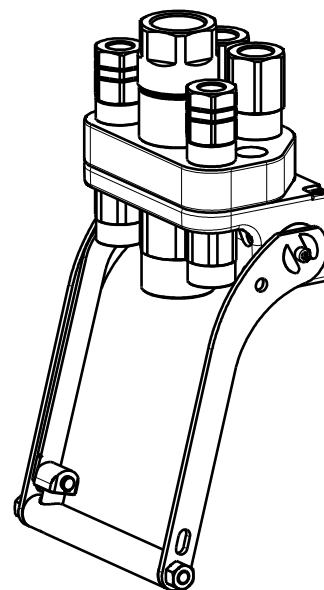

CONFIGURATIONS

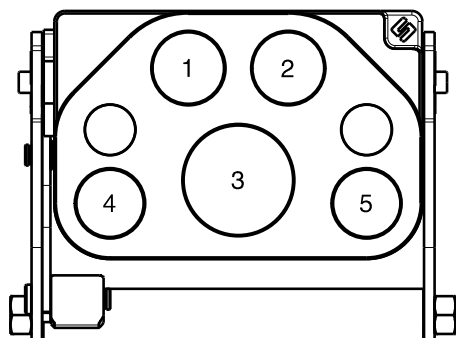

Possible configurations		
Pos	Coupling size	Predisposition for electrical connector
1	FAP15ZN	-
2	FAP15ZN	-
3	FAP21ZN	-
4	FAP13ZN	YES
5	FAP13ZN	YES

MultiCoupling (couplings included)		
Code	Name	Description
870016051	MULTI COMPLETE GR5 2B-1C-1E	2 FAP13 1/2 BSP - 1 FAP15 3/4 BSP - 1FAP21 1 BSP - CAP
870015063	MULTI COMPLETE GR5 2B-2C-1E	2 FAP13 1/2 BSP - 2 FAP15 3/4 BSP - 1 FAP21 1-1/4 BSP - CAP
870015097	MULTI COMPLETE GR5 2C-1E	2 FAP15 3/4 BSP - 1 FAP21 1 BSP - CAP
870016003	MULTI COMPLETE GR5 2C-1E	2 FAP15 3/4 BSP - 1 FAP21 1-1/4 BSP - CAP
870016012	MULTI COMPLETE GR5 2B-2C	2 FAP13 1/2 BSP - 2 FAP15 3/4 BSP - CAP
870015157	MULTI FIX GR5 1B-2C-1E	1 FAP13 1/2 BSP - 2 FAP15 3/4 BSP - 1 FAP21 1 BSP
870015257	MULTI MOBILE GR5 1B-2C-1E	1 FAP13 1/2 BSP - 2 FAP15 3/4 BSP - 1 FAP21 1 BSP
870016258	MULTI MOBILE GR5 1B-1C-1E	1 FAP13 1/2 BSP - 1 FAP15 3/4 BSP - 1 FAP21 1 BSP
870016257	MULTI MOBILE GR5 1C-1E	1 FAP15 3/4 BSP - 1 FAP21 1 BSP

MultiCoupling spare parts (couplings not included)	
Code	Name
806000314	MULTI FIX EMPTY GR5 2B-2C-1E
806000315	MULTI MOBILE EMPTY GR5 2B-2C-1E
815606260	CAP FIX MULTICOUPLING GR 175x117 V02
815606261	PARKING STATION MOBILE MULTICOUPLING GR 180x120 V02
815701055	SPARE KIT LEVER GROUP GR 250x212

Custom configurations available upon request

Fixed and mobile multicoupling

5,5 Kg and 2,6 Kg

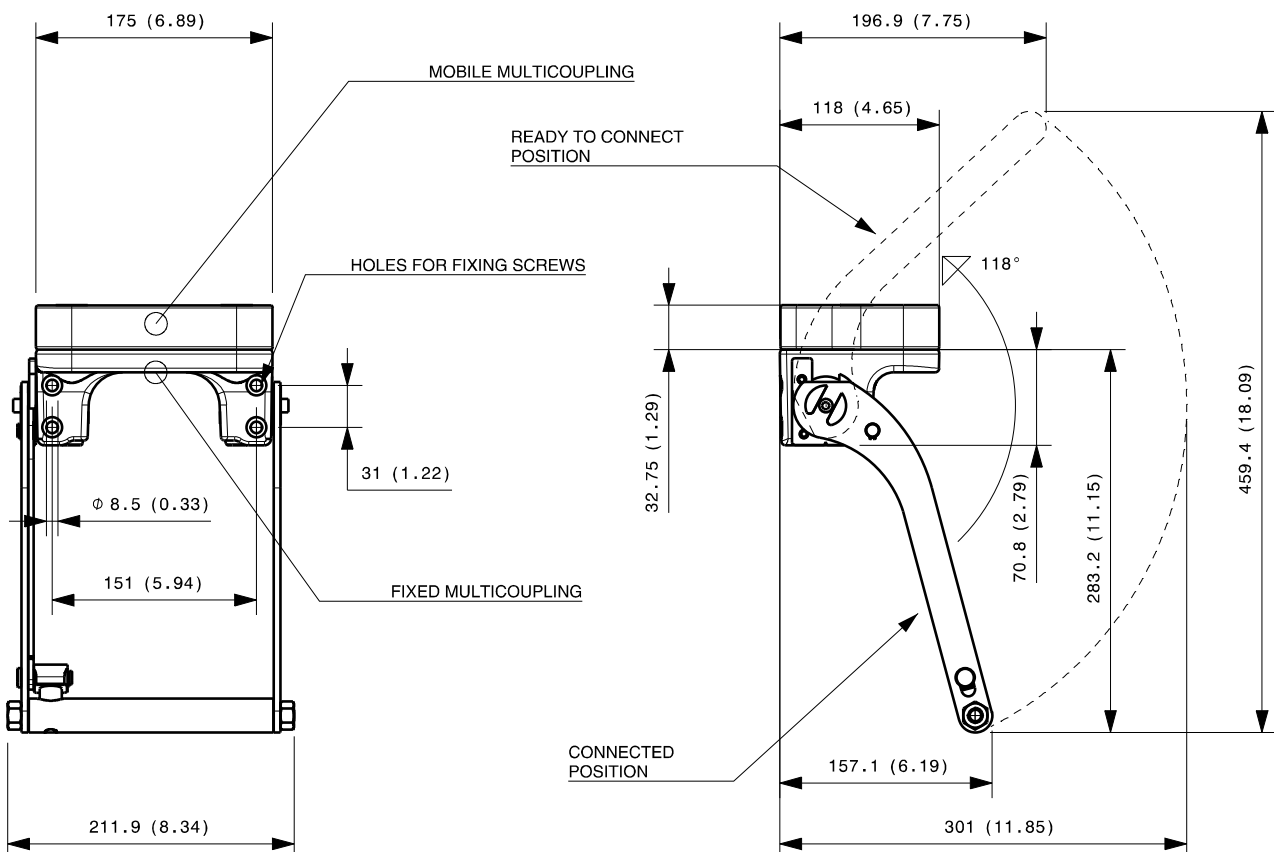

Dimensions in millimeters (inch)

Cap for fixed multicoupling 1,2 Kg

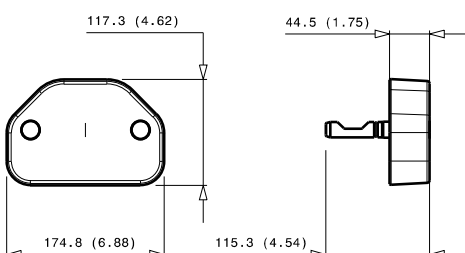

Parking station for mobile multicoupling 2,4 Kg

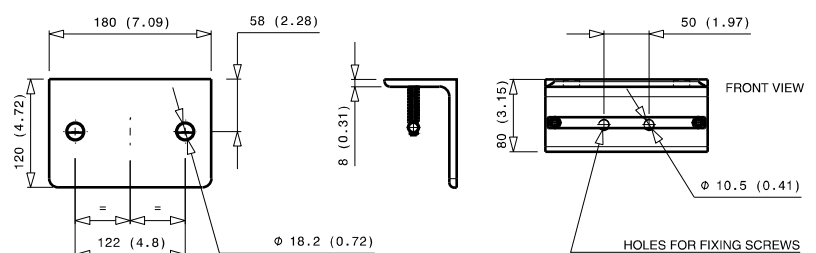

GR5 5C

Previous description	Max. Resistance	FAP9 (A)	FAP13 (B)	FAP15 (C)	FAP17 (D)	FAP21 (E)	FAP30 (G)
Body size		3/8"	1/2"	5/8"	3/4"	1"	1-1/2"
GR5-15ZN	23000 N			5			



DRAWING



CONFIGURATIONS

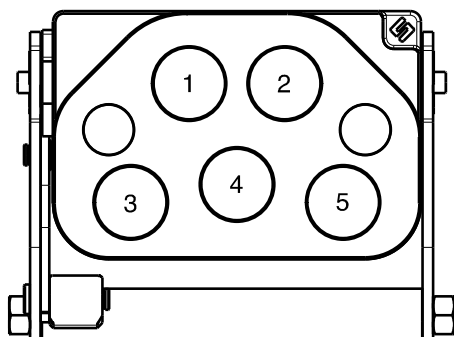

Possible configurations		
Pos	Coupling size	Predisposition for electrical connector
1	FAP15ZN	-
2	FAP15ZN	-
3	FAP15ZN	*
4	FAP15ZN	-
5	FAP15ZN	*

* upon request

MultiCoupling (couplings included)		
Code	Name	Description
870016010	MULTI COMPLETE GR5 5C	5 FAP15 3/4 BSP - CAP
870016110	MULTI FIX GR5 5C	5 FAP15 3/4 BSP
870016210	MULTI MOBILE GR5 5C	5 FAP15 3/4 BSP

MultiCoupling spare parts (couplings not included)	
Code	Name
806000326	MULTI FIX EMPTY GR5 5C
806000327	MULTI MOBILE EMPTY GR5 5C
815606260	CAP FIX MULTICOUPLING GR 175x117 V02
815606261	PARKING STATION MOBILE MULTICOUPLING GR 180x120 V02
815701055	SPARE KIT LEVER GROUP GR 250x212

Custom configurations available upon request

Fixed and mobile multicoupling

5,6 Kg and 2,8 Kg

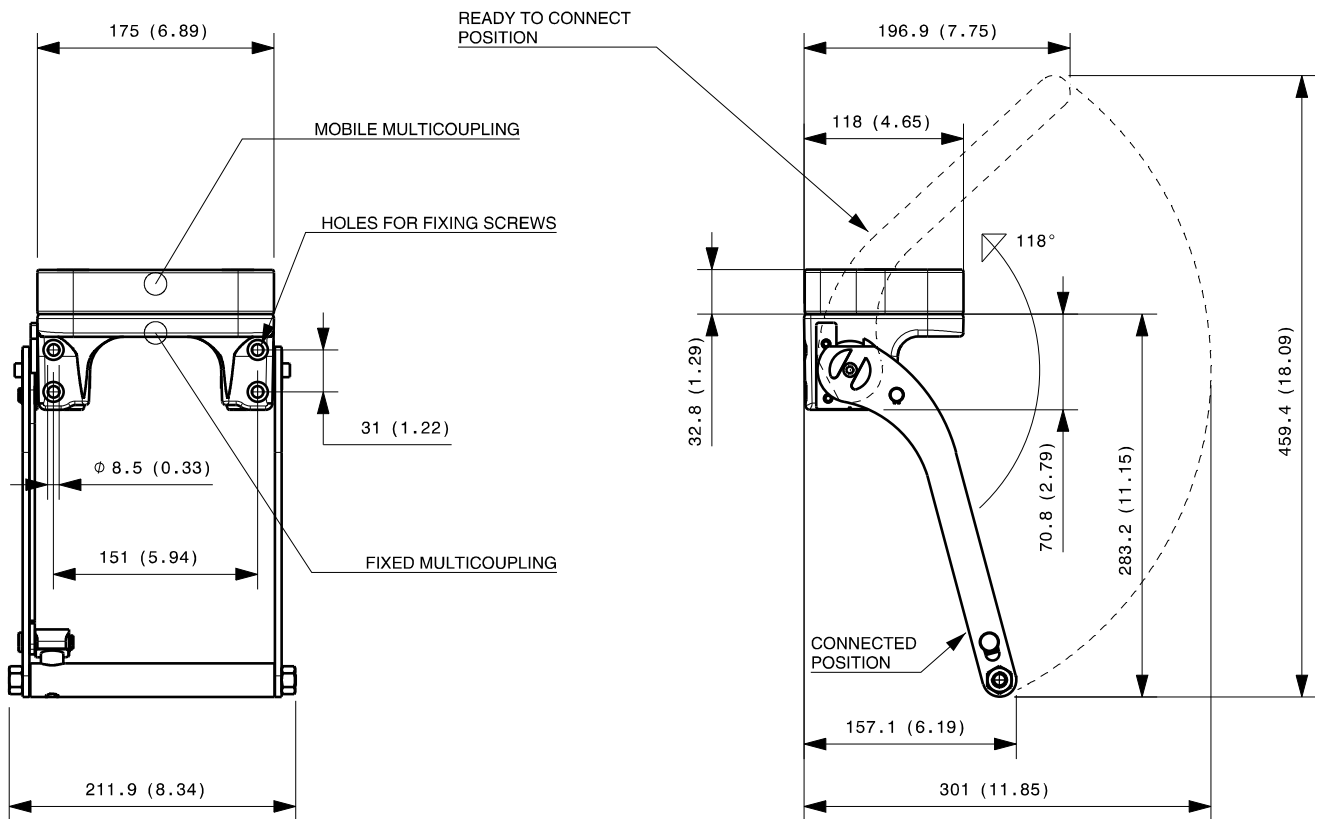

Dimensions in millimeters (inch)

Cap for fixed multicoupling 1,2 Kg

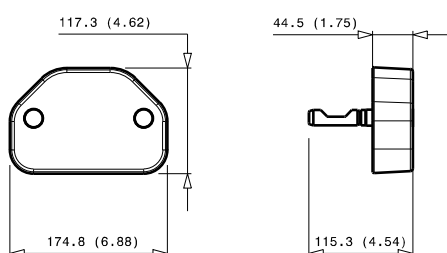

Parking station for mobile multicoupling 2,4 Kg

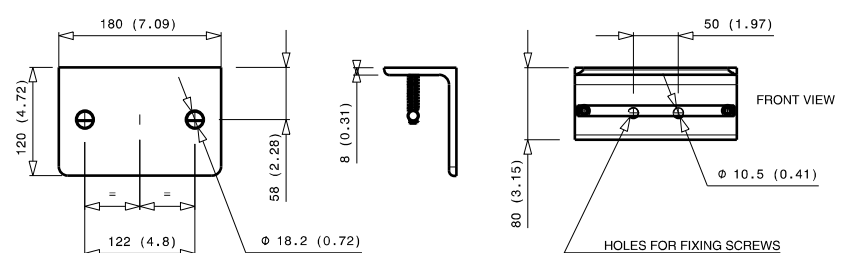

GR6 6A-2EC

Previous description	Max. Resistance	FAP9 (A)	FAP13 (B)	FAP15 (C)	FAP17 (D)	FAP21 (E)	FAP30 (G)
Body size		3/8"	1/2"	5/8"	3/4"	1"	1-1/2"
GR6-9ZN	18000 N	6	A				



DRAWING

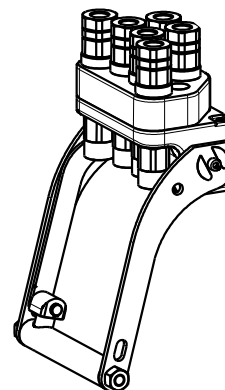

CONFIGURATIONS

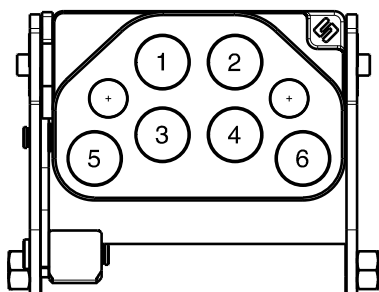

Possible configurations		
Pos	Coupling size	Predisposition for electrical connector
1	FAP9AZN	-
2	FAP9AZN	-
3	FAP9AZN	-
4	FAP9AZN	-
5	FAP9AZN	YES
6	FAP9AZN	YES

MultiCoupling (couplings included)		
Code	Name	Description
870000074	MULTI COMPLETE GR6 5A	5 FAP9A 3/8 BSP - CAP
870000075	MULTI COMPLETE GR6 6A	6 FAP9A 1/2 BSP - CAP
870000079	MULTI COMPLETE GR6 6A	6 FAP9A 3/8 BSP - CAP
870000080	MULTI COMPLETE GR6 4A	4 FAP9A 1/2 BSP - CAP
870000086	MULTI COMPLETE GR6 4A-1EC	4 FAP9A 1/2 NPT - 1EC7 - CAP
870015096	MULTI COMPLETE GR6 5A	5 FAP9A 1/4 BSP - CAP
870016044	MULTI COMPLETE GR6 4A	4 FAP9A 3/8 BSP - CAP
870000087	MULTI COMPLETE GR6 5A	2 FAP9A 3/8 NPT - 3 FAP9A 1/2 NPT - CAP
870000172	MULTI FIX GR6 2A	2 FAP9A 3/8 BSP
870000174	MULTI FIX GR6 5A	5 FAP9A 3/8 BSP
870000179	MULTI FIX GR6 6A	6 FAP9A 3/8 BSP
870000180	MULTI FIX GR6 4A	4 FAP9A 1/2 BSP
870000185	MULTI FIX GR6 4A	3 FAP9A 1/4 SAE - 1 FAP9A 3/8 SAE
870000187	MULTI FIX GR6 6A	6 FAP9A 1/2 NPT
870016144	MULTI FIX GR6 4A	4 FAP9A 3/8 BSP
870000273	MULTI MOBILE GR6 5A	5 FAP9A 3/8 BSP
870000275	MULTI MOBILE GR6 6A	6 FAP9A 1/2 BSP
870000279	MULTI MOBILE GR6 6A	6 FAP9A 3/8 BSP
870000280	MULTI MOBILE GR6 4A	4 FAP9A 1/2 BSP
870000285	MULTI MOBILE GR6 4A	3 FAP9A 1/4 SAE - 1 FAP9A 3/8 SAE
870000287	MULTI MOBILE GR6 6A	6 FAP9A 1/2 NPT

MultiCoupling spare parts (couplings not included)	
Code	Name
806000262	MULTI FIX EMPTY GR6 6A-2EC
806000263	MULTI MOBILE EMPTY GR6 6A-2EC
815606248	CAP FIX MULTICOUPLING GR 139x90
815606249	PARKING STATION MOBILE MULTICOUPLING GR 140x100
815701052	SPARE KIT LEVER GROUP GR 200x176

Custom configurations available upon request

Fixed and mobile multicoupling

3,7 Kg and 1,5 Kg

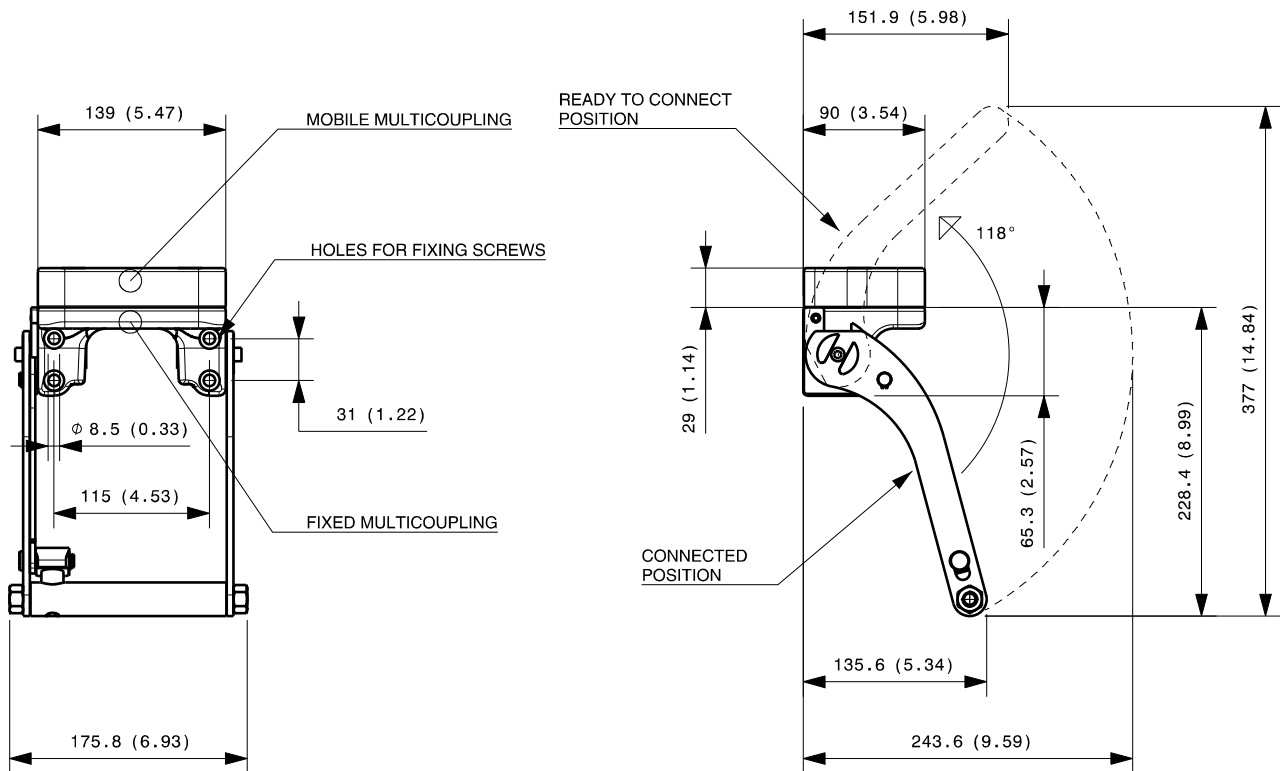

Dimensions in millimeters (inch)

Cap for fixed multicoupling 0,6 Kg

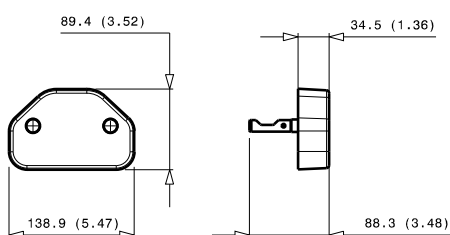

Parking station for mobile multicoupling 1,1 Kg

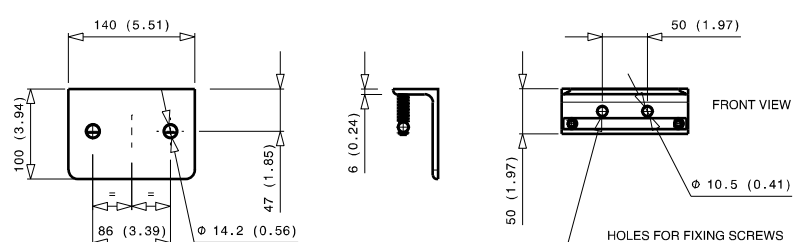

GR6 4A-2B-2EC

Previous description	Max. Resistance	FAP9 (A)		FAP13 (B)	FAP15 (C)	FAP17 (D)	FAP21 (E)	FAP30 (G)
Body size		3/8"	D	1/2"	5/8"	3/4"	1"	1-1/2"
GRT6ZN	23000 N	4	D	2				



DRAWING

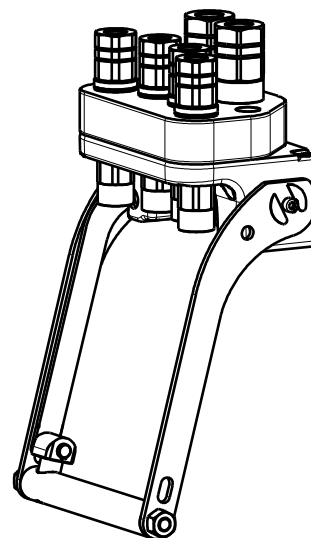

CONFIGURATIONS

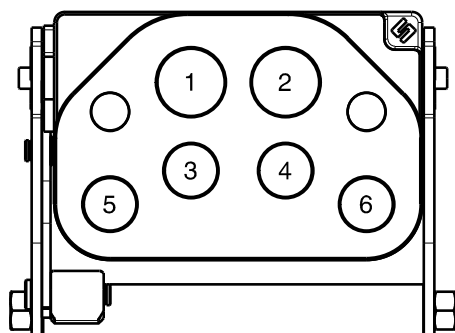

Possible configurations		
Pos	Coupling size	Predisposition for electrical connector
1	FAP13ZN	-
2	FAP13ZN	-
3	FAP9DZN	-
4	FAP9DZN	-
5	FAP9DZN	YES
6	FAP9DZN	YES

MultiCoupling (couplings included)		
Code	Name	Description
870015064	MULTI COMPLETE GR6 4A-2B	4 FAP9D 1/2 BSP - 2 FAP13 3/4 BSP - CAP
870016002	MULTI COMPLETE GR6 4A-2B	4 FAP9D 3/8 BSP - 2 FAP13 3/4 BSP - CAP
870016032	MULTI COMPLETE GR6 2A 2B	2 FAP9D 3/8 BSP - 2 FAP13 1/2 BSP - CAP
870016034	MULTI COMPLETE GR6 2A-2B-2EC	2 FAP9D 3/8 BSP - 2 FAP13 1/2 BSP - 2 EC6 - CAP
870016013	MULTI COMPLETE GR6 4A-1B	4 FAP9DZ 1/4 BSP - 1 FAP13ZN 1/2 BSP
870016076	MULTI COMPLETE GR6 3A-2B	3 FAP9D 3/8 NPT - 2 FAP13 1/2 NPT - CAP
870016069	MULTI COMPLETE GR6 4A-2B	4 FAP9D 3/8 BSP - 2 FAP13 1/2 BSP - CAP
870016077	MULTI COMPLETE GR6 4A-2B	4 FAP9D 3/8 NPT - 2 FAP13 1/2 NPT - CAP
870015190	MULTI FIX GR6 4A-2B	4 FAP9D 3/8 BSP - 1 FAP13 1/2 BSP - 1 FAP13 3/4 BSP
870016132	MULTI FIX GR6 2A 2B	2 FAP9D 3/8 BSP - 2 FAP13 1/2 BSP
870016134	MULTI FIX GR6 2A-2B-2EC	2 FAP9D 3/8 BSP - 2 FAP13 1/2 BSP - 2 EC6
870016169	MULTI FIX GR6 4A-2B	4 FAP9D 3/8 BSP - 2 FAP13 1/2 BSP
870015290	MULTI MOBILE GR6 4A-2B	4 FAP9D 3/8 BSP - 1 FAP13 1/2 BSP - 1 FAP13 3/4 BSP
870016232	MULTI MOBILE GR6 2A 2B	2 FAP9D 3/8 BSP - 2 FAP13 1/2 BSP
870016234	MULTI MOBILE GR6 2A-2B-2EC	2 FAP9D 3/8 BSP - 2 FAP13 1/2 BSP - 2 EC6
870016269	MULTI MOBILE GR6 4A-2B	4 FAP9D 3/8 BSP - 2 FAP13 1/2 BSP

MultiCoupling spare parts (couplings not included)	
Code	Name
806000294	MULTI FIX EMPTY GR6 4A-2B-2EC
806000295	MULTI MOBILE EMPTY GR6 4A-2B-2EC
815606256	CAP FIX MULTICOUPLING GR 175x117
815606257	PARKING STATION MOBILE MULTICOUPLING GR 180x120
815700999	SPARE KIT LEVER GROUP GR 250x212

Custom configurations available upon request

Fixed and mobile multicoupling

5,9 Kg and 2,8 Kg

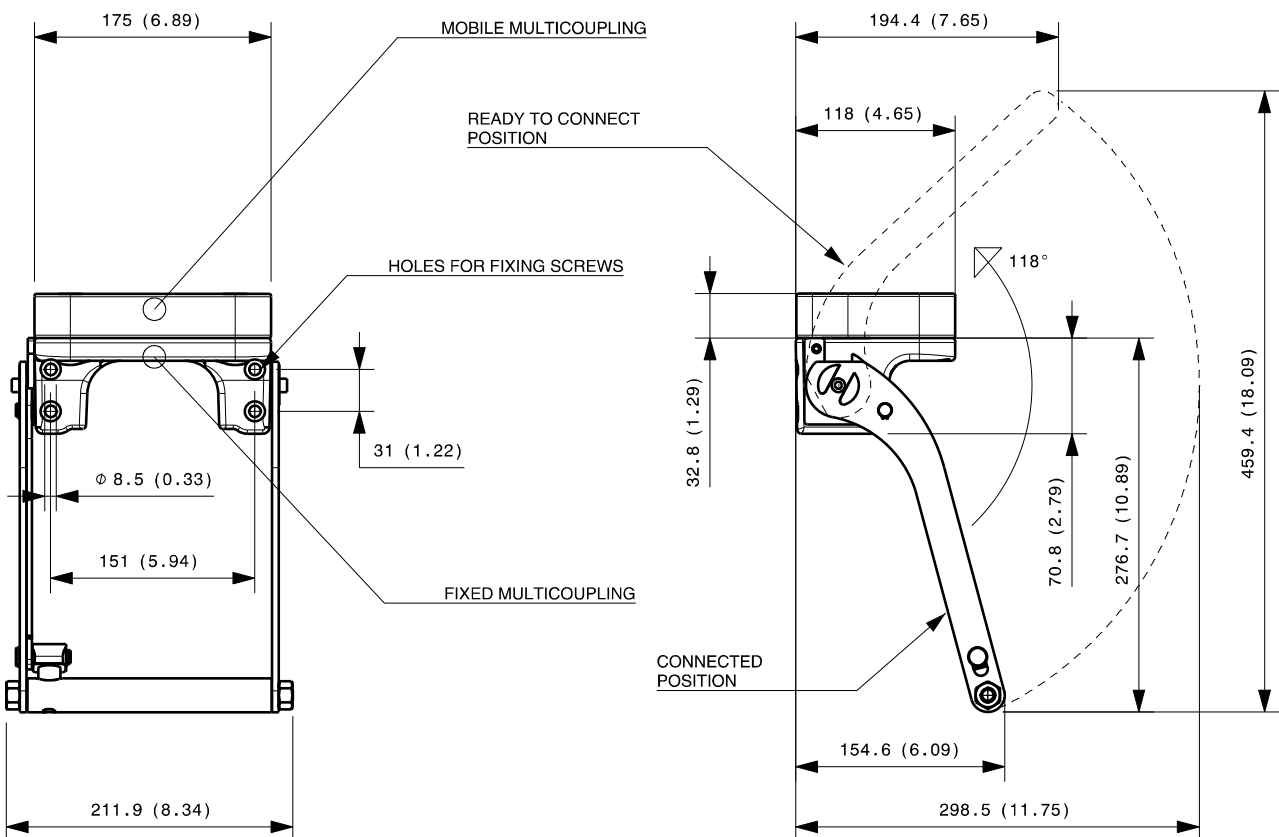

Dimensions in millimeters (inch)

Cap for fixed multicoupling 1,1 Kg

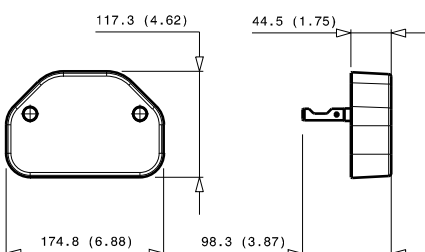

Parking station for mobile multicoupling 2,2 Kg

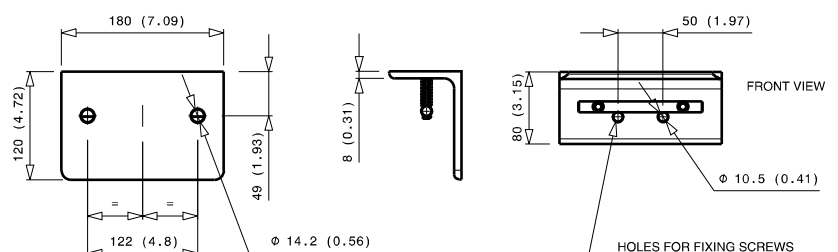

GR6 4B-2D-4EC

Previous description	Max. Resistance	FAP9 (A)	FAP13 (B)	FAP15 (C)	FAP17 (D)	FAP21 (E)	FAP30 (G)
Body size		3/8"	1/2"	5/8"	3/4"	1"	1-1/2"
GR6ABZN	23000 N		4		2		



DRAWING

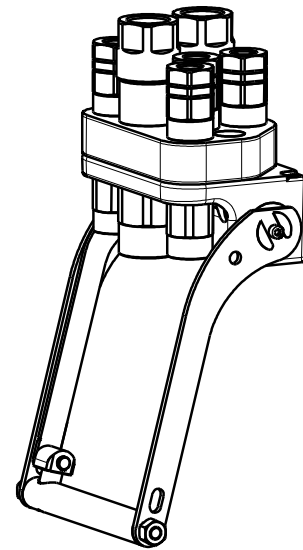

CONFIGURATIONS

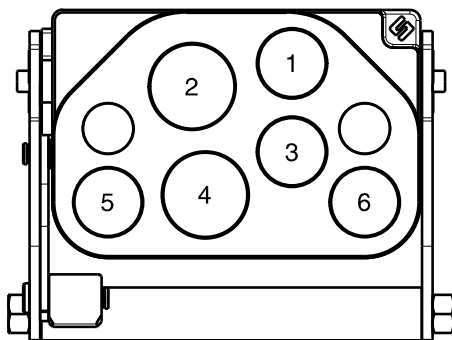

Possible configurations		
Pos	Coupling size	Predisposition for electrical connector
1	FAP13ZN	YES
2	FAP17ZN	-
3	FAP13ZN	YES
4	FAP17ZN	-
5	FAP13ZN	YES
6	FAP13ZN	YES

MultiCoupling (couplings included)		
Code	Name	Description
870015073	MULTI COMPLETE GR6 4B-2D	4 FAP13 1/2 BSP - 2 FAP17 3/4 BSP - CAP
870016031	MULTI COMPLETE GR6 2B 2D 2EC	2 FAP13 1/2 BSP - 2 FAP17 1 BSP - 2EC7 - CAP
870016036	MULTI COMPLETE GR6 4B-2D	2 FAP13 1/2 BSP - 2 FAP13 3/4 BSP - 1 FAP17 3/4 BSP - 1 FAP17 1 BSP - CAP
870016063	MULTI COMPLETE GR6 4B-2D	4 FAP13 1/2 NPT - 2 FAP17 3/4 NPT - CAP
870015173	MULTI FIX GR6 4B-2D	4 FAP13 1/2 BSP - 2 FAP17 3/4 BSP
870016131	MULTI FIX GR6 2B 2D 2EC	2 FAP13 1/2 BSP - 2 FAP17 1 BSP - 2EC7
870016149	MULTI FIX GR6 4B-2D	2 FAP13 1/2 BSP - 2 FAP13 3/4 BSP - 2 FAP17 1 BSP
870015273	MULTI MOBILE GR6 4B-2D	4 FAP13 1/2 BSP - 2 FAP17 3/4 BSP
870016231	MULTI MOBILE GR6 2B 2D 2EC	2 FAP13 1/2 BSP - 2 FAP17 1 BSP - 2EC7
870016249	MULTI MOBILE GR6 4B-2D	2 FAP13 1/2 BSP - 2 FAP13 3/4 BSP - 2 FAP17 1 BSP

MultiCoupling spare parts (couplings not included)		
Code	Name	
806000322	MULTI FIX EMPTY GR6 4B-2D-4EC	
806000323	MULTI MOBILE EMPTY GR6 4B-2D-4EC	
815606260	CAP FIX MULTICOUPLING GR 175x117 V02	
815606261	PARKING STATION MOBILE MULTICOUPLING GR 180x120 V02	
815701055	SPARE KIT LEVER GROUP GR 250x212	

Custom configurations available upon request

Fixed and mobile multicoupling

5,4 Kg and 2,6 Kg

GR

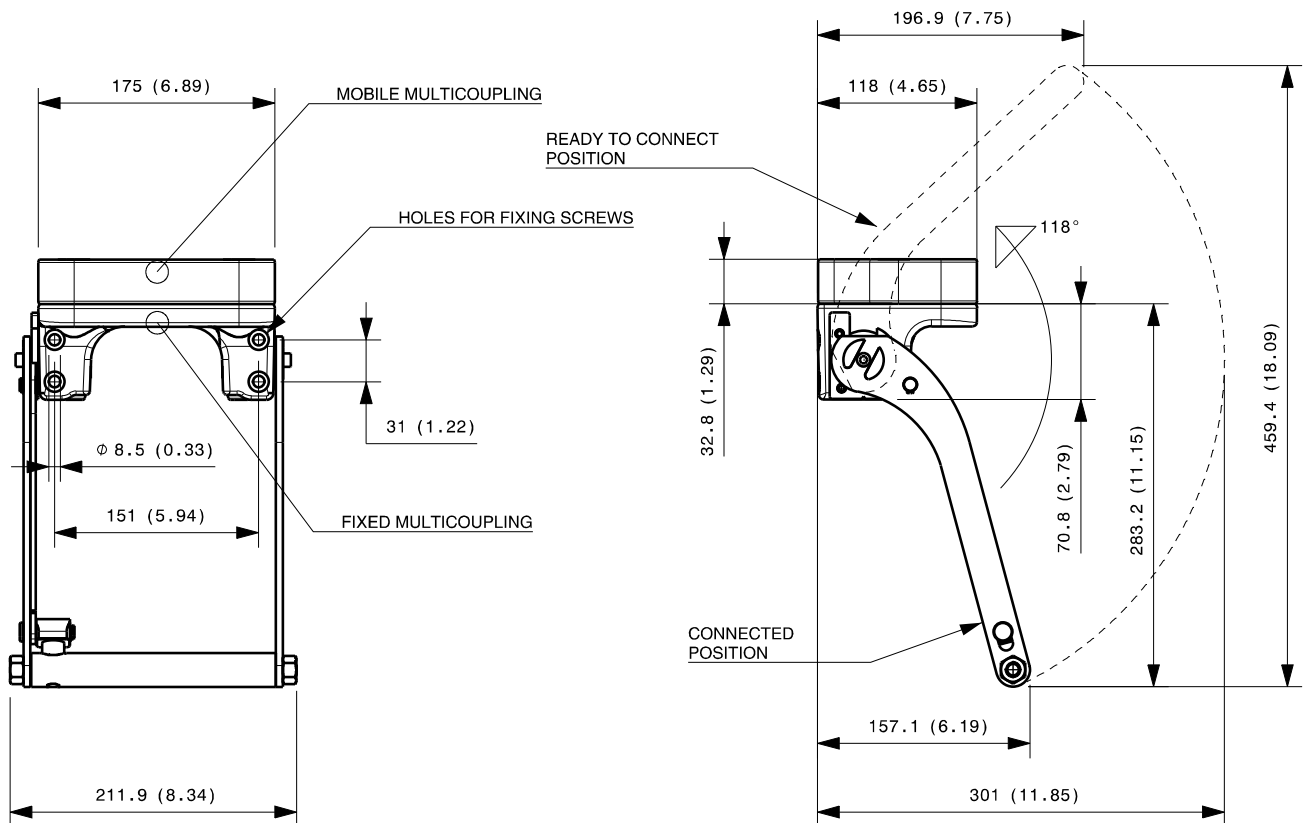

Dimensions in millimeters (inch)

Cap for fixed multicoupling 1,2 Kg

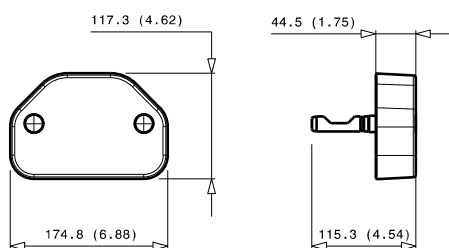

Parking station for mobile multicoupling 2,4 Kg

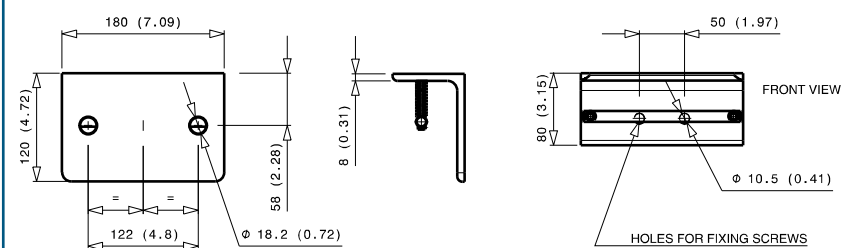

GR6 2A-2B-2C-2EC

Previous description	Max. Resistance	FAP9 (A)	FAP13 (B)	FAP15 (C)	FAP17 (D)	FAP21 (E)	FAP30 (G)
Body size		3/8"	1/2"	5/8"	3/4"	1"	1-1/2"
GRM6MCZN	23000 N	2 D	2	2			



DRAWING



CONFIGURATIONS

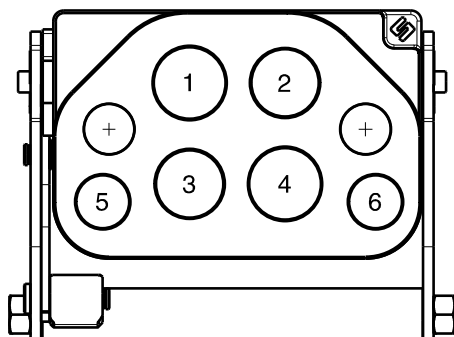

Possible configurations		
Pos	Coupling size	Predisposition for electrical connector
1	FAP15ZN	-
2	FAP13ZN	-
3	FAP13ZN	-
4	FAP15ZN	-
5	FAP9DZN	YES
6	FAP9DZN	YES

MultiCoupling (couplings included)		
Code	Name	Description
870016016	MULTI COMPLETE GR6 2A-2B-2C	2 FAP9D 3/8 BSP - 2 FAP13 1/2 BSP - 2 FAP15 3/4 BSP - CAP
870016028	MULTI COMPLETE GR6 1A-2B-2C	1 FAP9D 3/8 BSP - 2 FAP13 1/2 BSP - 2 FAP15 3/4 BSP - CAP
870016116	MULTI FIX GR6 2A-2B-2C	2 FAP9D 3/8 BSP - 2 FAP13 1/2 BSP - 2 FAP15 3/4 BSP
870016128	MULTI FIX GR6 1A-2B-2C	1 FAP9D 3/8 BSP - 2 FAP13 1/2 BSP - 2 FAP15 3/4 BSP
870016135	MULTI FIX GR6 1A-2B-2C	1 FAP9D 1/2 BSP - 2 FAP13 1/2 BSP - 2 FAP15 3/4 BSP
870016165	MULTI FIX GR6 2A-2B-2C	1 FAP9D 3/8 BSP - 1 FAP9D 1/2 BSP - 2 FAP13 1/2 BSP - 2 FAP15 3/4 BSP
870016216	MULTI MOBILE GR6 2A-2B-2C	2 FAP9D 3/8 BSP - 2 FAP13 1/2 BSP - 2 FAP15 3/4 BSP
870016228	MULTI MOBILE GR6 1A-2B-2C	1 FAP9D 3/8 BSP - 2 FAP13 1/2 BSP - 2 FAP15 3/4 BSP
870016235	MULTI MOBILE GR6 1A-2B-2C	1 FAP9D 1/2 BSP - 2 FAP13 1/2 BSP - 2 FAP15 3/4 BSP
870016265	MULTI MOBILE GR6 2A-2B-2C	1 FAP9D 3/8 BSP - 1 FAP9D 1/2 BSP - 2 FAP13 1/2 BSP - 2 FAP15 3/4 BSP

MultiCoupling spare parts (couplings not included)	
Code	Name
806000318	MULTI FIX EMPTY GR6 2A-2B-2C-2EC
806000319	MULTI MOBILE EMPTY GR6 2A-2B-2C-2EC
815606260	CAP FIX MULTICOUPLING GR 175x117 V02
815606261	PARKING STATION MOBILE MULTICOUPLING GR 180x120 V02
815701055	SPARE KIT LEVER GROUP GR 250x212

Custom configurations available upon request

Fixed and mobile multicoupling

5,7 Kg and 2,9 Kg

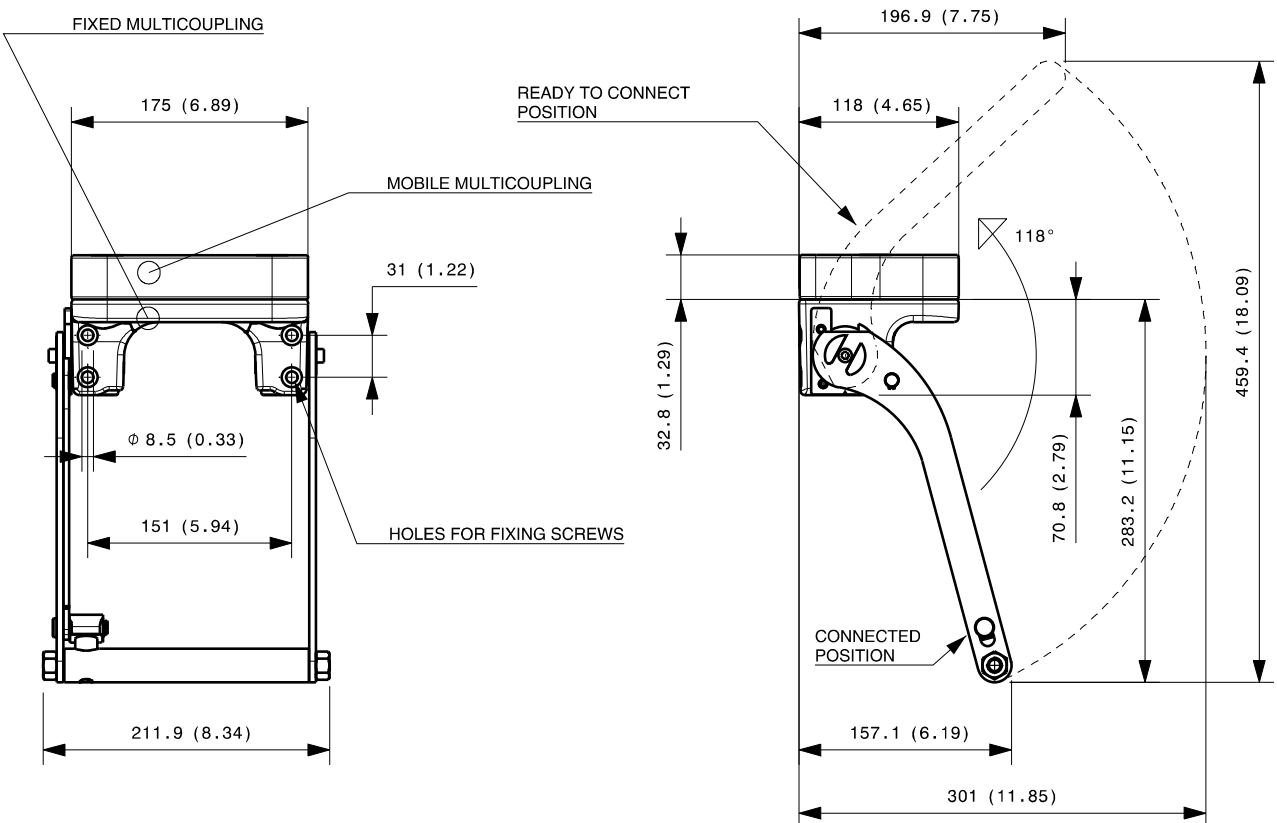

Dimensions in millimeters (inch)

Cap for fixed multicoupling 1,2 Kg

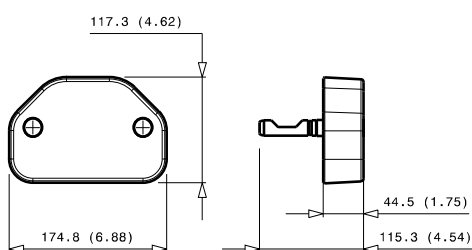

Parking station for mobile multicoupling 2,4 Kg

2,4 Kg

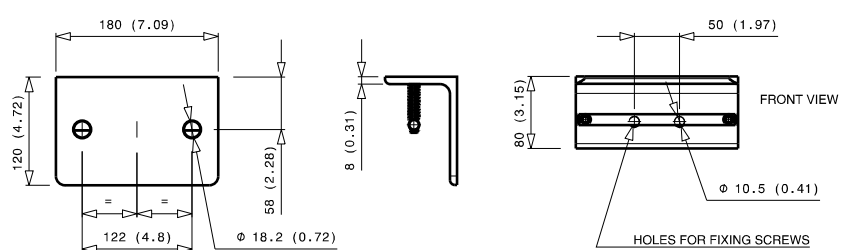

GR6 6B-2EC

Previous description	Max. Resistance Body size	FAP9 (A) 3/8"	FAP13 (B) 1/2"	FAP15 (C) 5/8"	FAP17 (D) 3/4"	FAP21 (E) 1"	FAP30 (G) 1-1/2"
GR6-13ZN	23000 N		6				



DRAWING

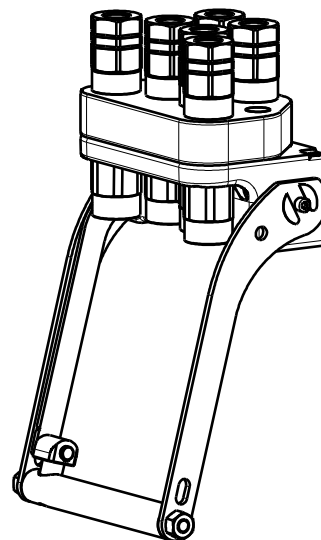

CONFIGURATIONS

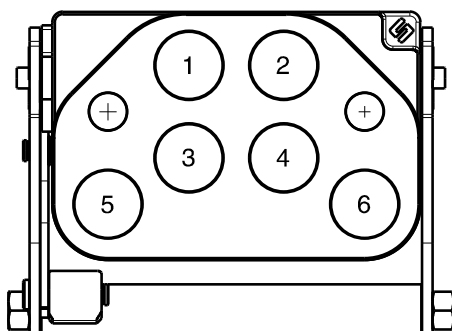

Possible configurations		
Pos	Coupling size	Predisposition for electrical connector
1	FAP13ZN	-
2	FAP13ZN	-
3	FAP13ZN	-
4	FAP13ZN	-
5	FAP13ZN	YES
6	FAP13ZN	YES

MultiCoupling (couplings included)		
Code	Name	Description
870002030	MULTI COMPLETE GR6 6B	6 FAP13 3/4 BSP - CAP
870002031	MULTI COMPLETE GR6 6B	6 FAP13 1/2 BSP - CAP
870002022	MULTI COMPLETE GR6 5B	5 FAP13 1/2 BSP - CAP
870002033	MULTI COMPLETE GR6 6B	6 FAP13 1/2 NPT - CAP
870002130	MULTI FIX GR6 6B	6 FAP13 3/4 BSP
870002131	MULTI FIX GR6 6B	6 FAP13 1/2 BSP
870002209	MULTI MOBILE GR6 2B	2 FAP13 3/4 BSP
870002230	MULTI MOBILE GR6 6B	6 FAP13 3/4 BSP
870002231	MULTI MOBILE GR6 6B	6 FAP13 1/2 BSP

MultiCoupling spare parts (couplings not included)	
Code	Name
806000292	MULTI FIX EMPTY GR6 6B-2EC
806000293	MULTI MOBILE EMPTY GR6 6B-2EC
815606256	CAP FIX MULTICOUPLING GR 175x117
815606257	PARKING STATION MOBILE MULTICOUPLING GR 180x120
815700999	SPARE KIT LEVER GROUP GR 250x212

Custom configurations available upon request

Fixed and mobile multicoupling

5,8 Kg and 2,7 Kg

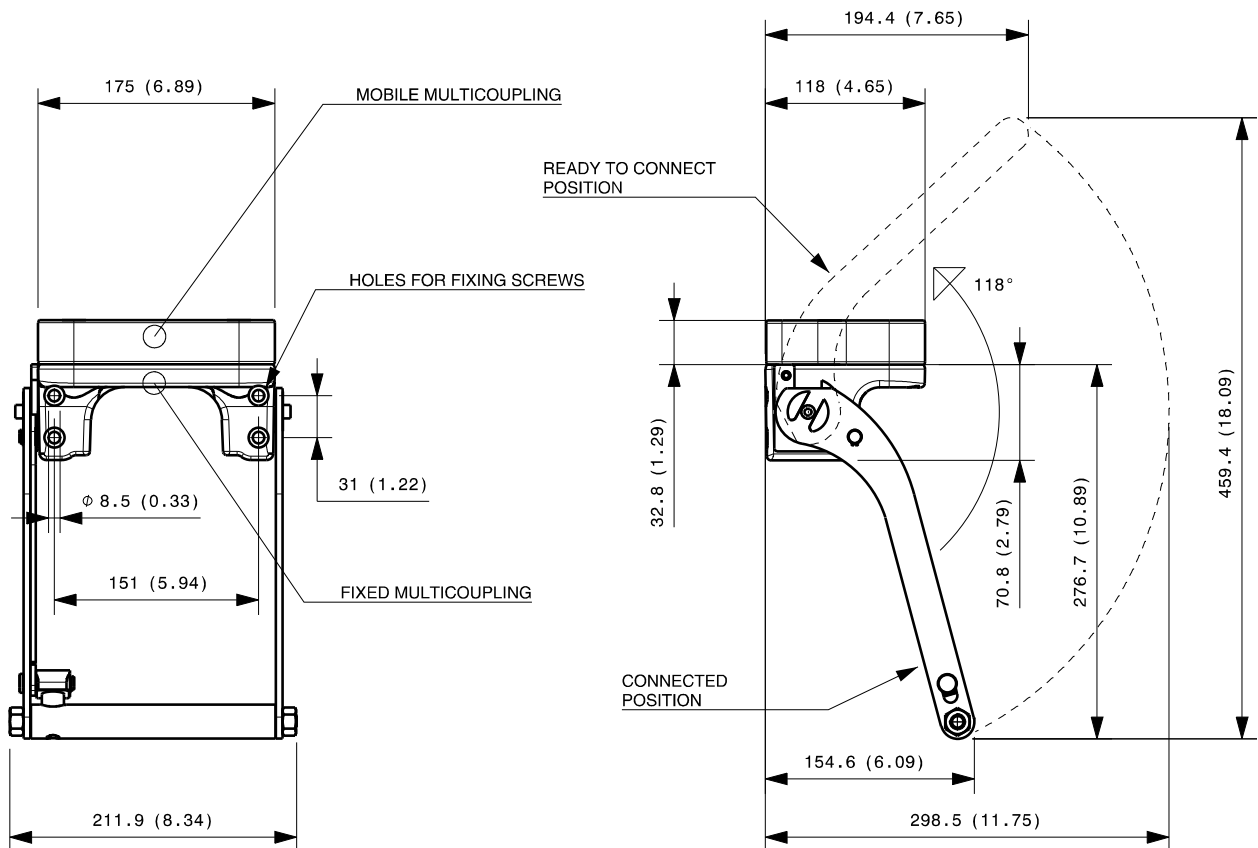

Dimensions in millimeters (inch)

Cap for fixed multicoupling 1,1 Kg

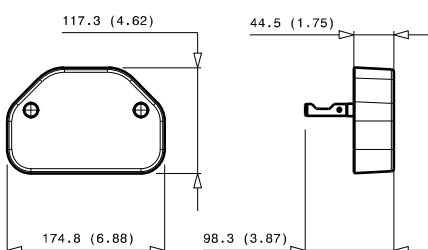

Parking station for mobile multicoupling 2,2 Kg

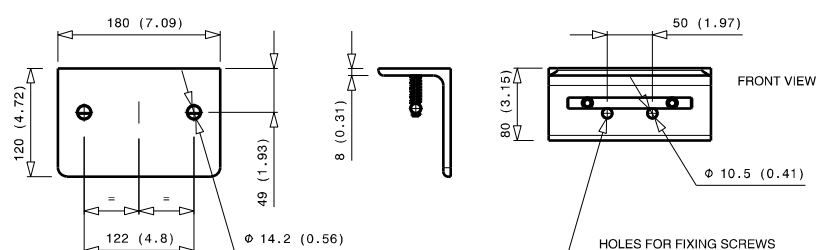

GR6 3A-1B-1C-1D-2EC

Previous description	Max. Resistance	FAP9 (A)		FAP13 (B)	FAP15 (C)	FAP17 (D)	FAP21 (E)	FAP30 (G)
Body size		3/8"	D	1/2"	5/8"	3/4"	1"	1-1/2"
GRC6ZN	23000 N	3	D	1	1	1		



DRAWING

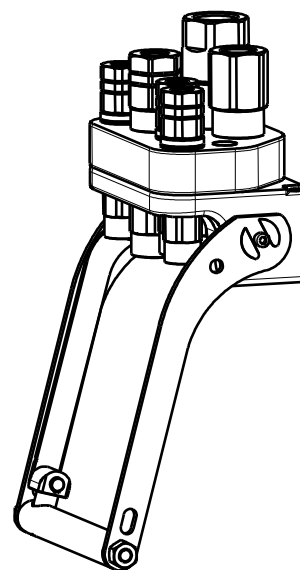

CONFIGURATIONS

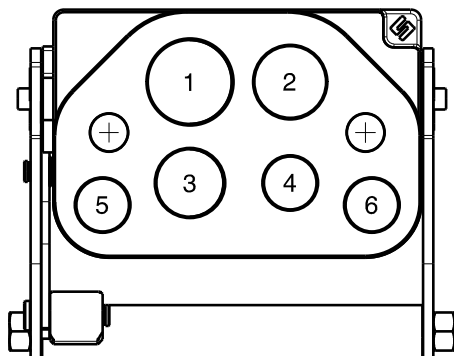

Possible configurations		
Pos	Coupling size	Predisposition for electrical connector
1	FAP17ZN	-
2	FAP15ZN	-
3	FAP13ZN	-
4	FAP9DZN	-
5	FAP9DZN	YES
6	FAP9DZN	YES

MultiCoupling (couplings included)

Code	Name	Description
870016017	MULTI COMPLETE GR6 3A-1B-1C-1D	3 FAP9D 3/8 BSP - 1 FAP13 1/2 BSP - 1 FAP15 3/4 BSP - 1 FAP17 1 BSP - CAP
870016117	MULTI FIX GR6 3A-1B-1C-1D	3 FAP9D 3/8 BSP - 1 FAP13 1/2 BSP - 1 FAP15 3/4 BSP - 1 FAP17 1 BSP
870016123	MULTI FIX GR6 3A-1B-1C-1D	3 FAP9D 3/8 SAE - 1 FAP13 1/2 SAE - 1 FAP15 3/4 SAE - 1 FAP17 1 SAE
870016217	MULTI MOBILE GR6 3A-1B-1C-1D	3 FAP9D 3/8 BSP - 1 FAP13 1/2 BSP - 1 FAP15 3/4 BSP - 1 FAP17 1 BSP
870016223	MULTI MOBILE GR6 3A-1B-1C-1D	3 FAP9D 3/8 SAE - 1 FAP13 1/2 SAE - 1 FAP15 3/4 SAE - 1 FAP17 1 SAE

MultiCoupling spare parts (couplings not included)

Code	Name
806000296	MULTI FIX EMPTY GR6 3A-1B-1C-1D-2EC
806000297	MULTI MOBILE EMPTY GR6 3A-1B-1C-1D-2EC
815606258	CAP FIX MULTICOUPLING GR 175x117 V01
815606259	PARKING STATION MOBILE MULTICOUPLING GR 180x120 V01
815700999	SPARE KIT LEVER GROUP GR 250x212

Custom configurations available upon request

Fixed and mobile multicoupling

5,8 Kg and 2,8 Kg

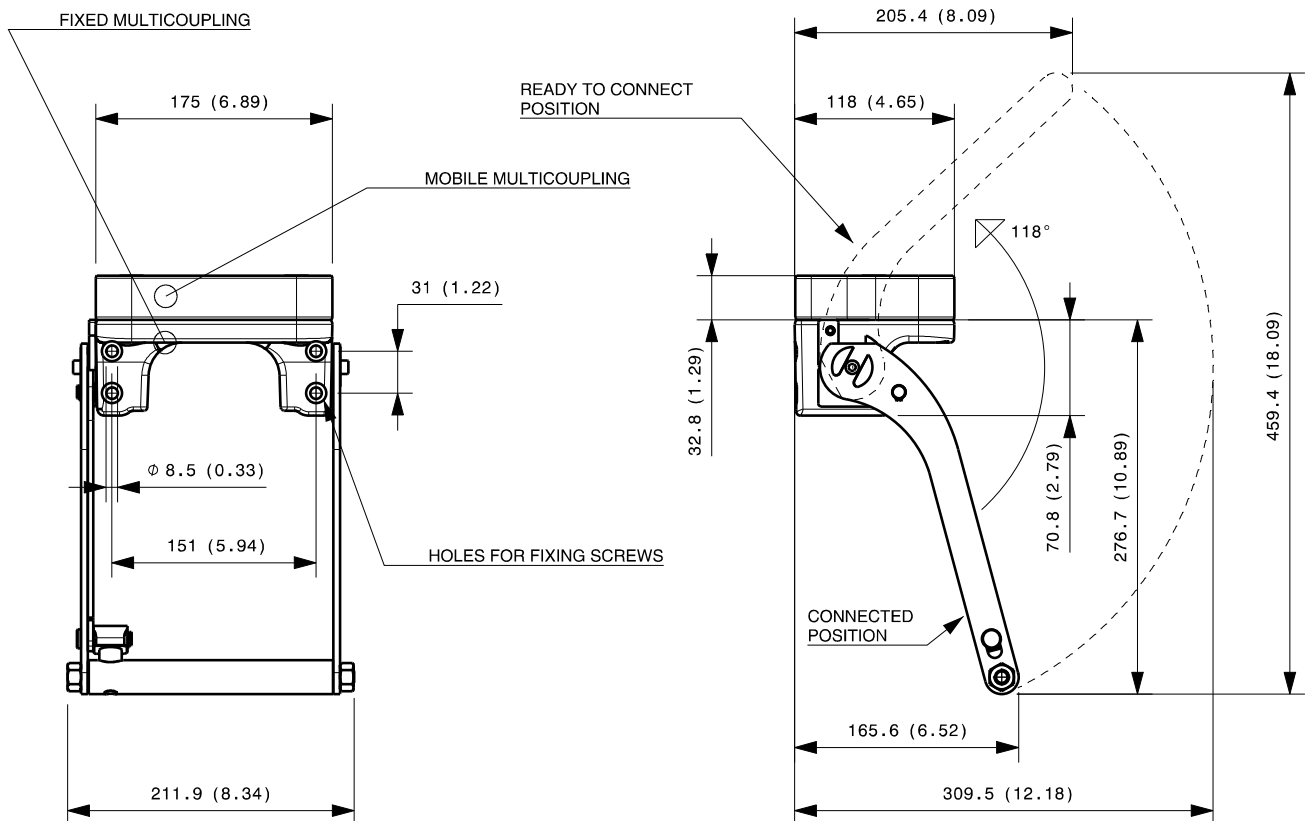

Dimensions in millimeters (inch)

Cap for fixed multicoupling 1,1 Kg

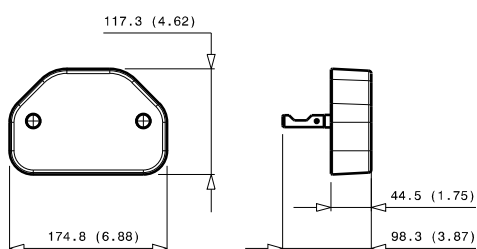

Parking station for mobile multicoupling 2,2 Kg

2,2 Kg

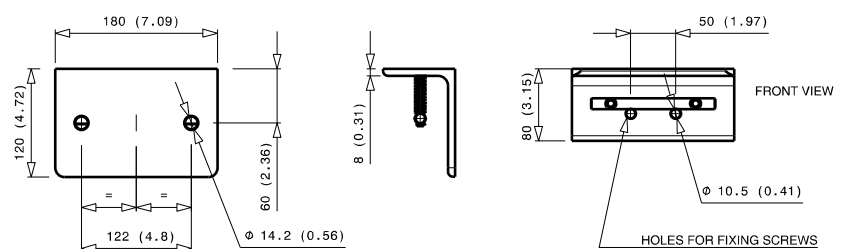

GR6 2A-2C-2D-2EC

Previous description	Max. Resistance	FAP9 (A)		FAP13 (B)	FAP15 (C)	FAP17 (D)	FAP21 (E)	FAP30 (G)
Body size		3/8"	D	1/2"	5/8"	3/4"	1"	1-1/2"
GRM6ZN	23000 N	2	D		2	2		



DRAWING

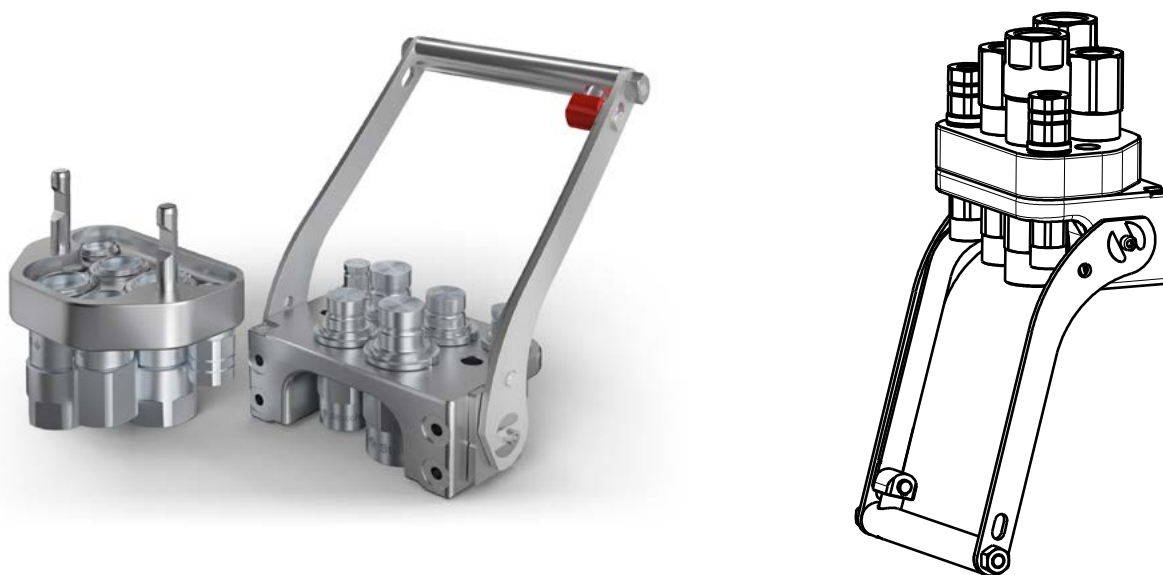

CONFIGURATIONS

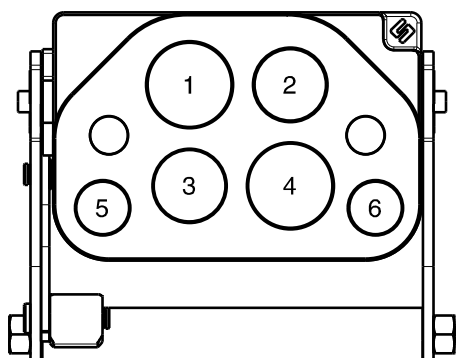

Possible configurations		
Pos	Coupling size	Predisposition for electrical connector
1	FAP17ZN	-
2	FAP15ZN	-
3	FAP15ZN	-
4	FAP17ZN	-
5	FAP9DZN	YES
6	FAP9DZN	YES

MultiCoupling (couplings included)		
Code	Name	Description
870015062	MULTI COMPLETE GR6 1A-2C-2D	1 FAP9D 3/8 BSP - 2 FAP15 3/4 BSP - 2 FAP17 1 BSP - CAP
870015092	MULTI COMPLETE GR6 2A-2C-2D	2 FAP9D 3/8 BSP - 2 FAP15 3/4 BSP - 2 FAP17 1 BSP - CAP
870015094	MULTI COMPLETE GR6 2A-2C-1D	2 FAP9D 3/8 BSP - 2 FAP15 3/4 BSP - 1 FAP17 1 BSP - CAP
870015098	MULTI COMPLETE GR6 2A-2D	2 FAP9D 3/8 BSP - 2 FAP17 1 BSP - CAP
870015155	MULTI FIX GR6 2D-2EC	2 FAP17 1 BSP - 2 EC6
870015198	MULTI FIX GR6 2A-2D	2 FAP9D 3/8 BSP - 2 FAP17 1 BSP
870015255	MULTI MOBILE GR6 2D-2EC	2 FAP17 1 BSP - 2 EC6
870015298	MULTI MOBILE GR6 2A-2D	2 FAP9D 3/8 BSP - 2 FAP17 1 BSP

MultiCoupling spare parts (couplings not included)	
Code	Name
806000300	MULTI FIX EMPTY GR6 2A-2C-2D-2EC
806000301	MULTI MOBILE EMPTY GR6 2A-2C-2D-2EC
815606258	CAP FIX MULTICOUPLING GR 175x117 V01
815606259	PARKING STATION MOBILE MULTICOUPLING GR 180x120 V01
815700999	SPARE KIT LEVER GROUP GR 250x212

Custom configurations available upon request

Fixed and mobile multicoupling

5,7 Kg and 2,6 Kg

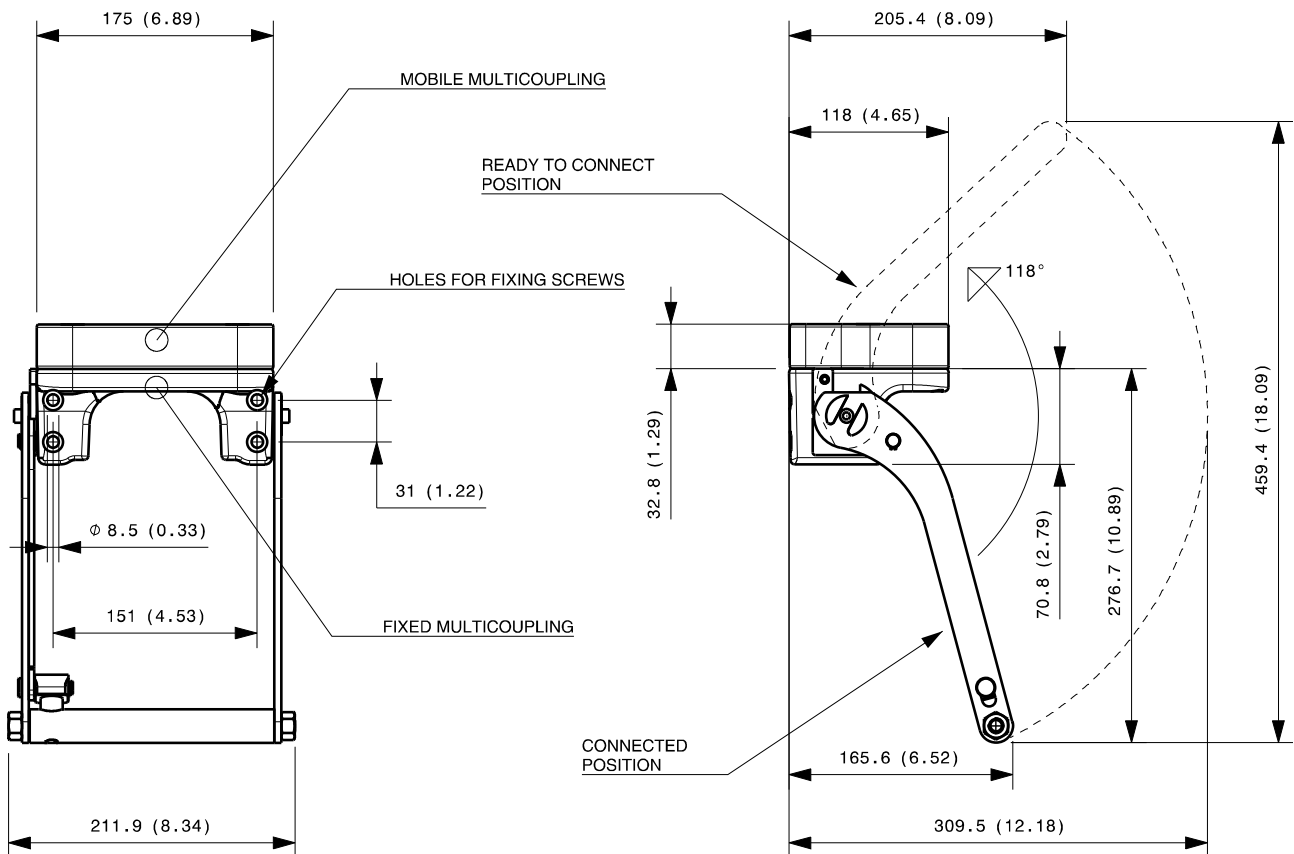

Dimensions in millimeters (inch)

Cap for fixed multicoupling 1,1 Kg

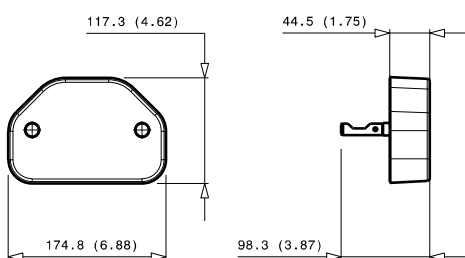

Parking station for mobile multicoupling 2,2 Kg

2,2 Kg

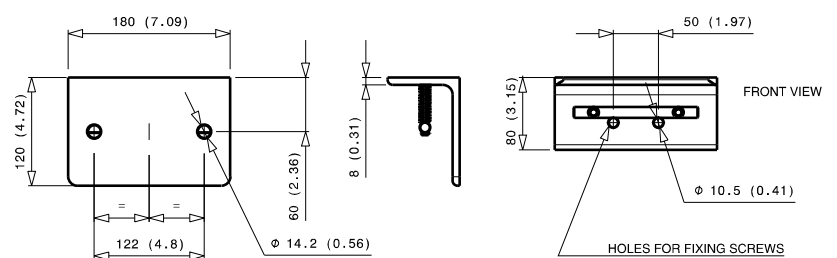

GR6 2A-2B-1D-1E-2EC

Previous description	Max. Resistance	FAP9 (A)		FAP13 (B)	FAP15 (C)	FAP17 (D)	FAP21 (E)	FAP30 (G)
Body size		3/8"	D	1/2"	5/8"	3/4"	1"	1-1/2"
GRU6ZN	23000 N	2	D	2		1	1	



DRAWING

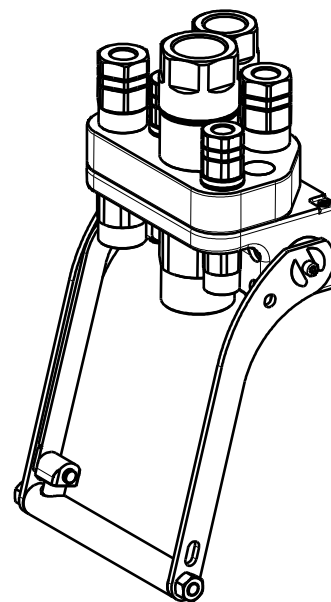

CONFIGURATIONS

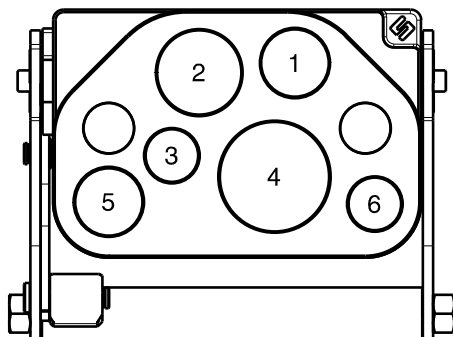

Possible configurations		
Pos	Coupling size	Predisposition for electrical connector
1	FAP13ZN	-
2	FAP17ZN	-
3	FAP9DZN	YES
4	FAP21ZN	-
5	FAP13ZN	-
6	FAP9DZN	YES

MultiCoupling (couplings included)		
Code	Name	Description
870015059	MULTI COMPLETE GR6 1A-2B-1D-1E	1 FAP9D 3/8 BSP - 2 FAP13 1/2 BSP - 1 FAP17 1 BSP - 1 FAP21 1-1/4 BSP - CAP
870015070	MULTI COMPLETE GR6 1A-2B-1D-1E	1 FAP9D 3/8 BSP - 2 FAQ13 1/2 BSP - 1 FAP17 1 BSP - 1 FAP21 1-1/4 BSP - CAP
870015093	MULTI COMPLETE GR6 1A-2B-1D	1 FAP9D 3/8 BSP - 2 FAP13 1/2 BSP - 1 FAP17 3/4 BSP - CAP
870016080	MULTI COMPLETE GR6 2A-2B-1D-1E	2 FAP9D 3/8 BSP - 2 FAP13 1/2 BSP - 1 FAP17 3/4 BSP - 1 FAP21 1-1/4 BSP - CAP
870015170	MULTI FIX GR6 1A-2B-1D-1E	1 FAP9D 3/8 BSP - 2 FAQ13 1/2 BSP - 1 FAP17 1 BSP - 1 FAP21 1-1/4 BSP
870015270	MULTI MOBILE GR6 1A-2B-1D-1E	1 FAP9D 3/8 BSP - 2 FAQ13 1/2 BSP - 1 FAP17 1 BSP - 1 FAP21 1-1/4 BSP
870016037	MULTI COMPLETE GR6 2A-2B-1D-1E	2 FAP9D 1/2 BSP - 2 FAP13 3/4 BSP - 1 FAP17 1 BSP - 1 FAP21 1-1/4 BSP - CAP

MultiCoupling spare parts (couplings not included)	
Code	Name
806000306	MULTI FIX EMPTY GR6 2A-2B-1D-1E-2EC
806000307	MULTI MOBILE EMPTY GR6 2A-2B-1D-1E-2EC
815606260	CAP FIX MULTICOUPLING GR 175x117 V02
815606261	PARKING STATION MOBILE MULTICOUPLING GR 180x120 V02
815701055	SPARE KIT LEVER GROUP GR 250x212

Custom configurations available upon request

Fixed and mobile multicoupling

5,4 Kg and 2,6 Kg

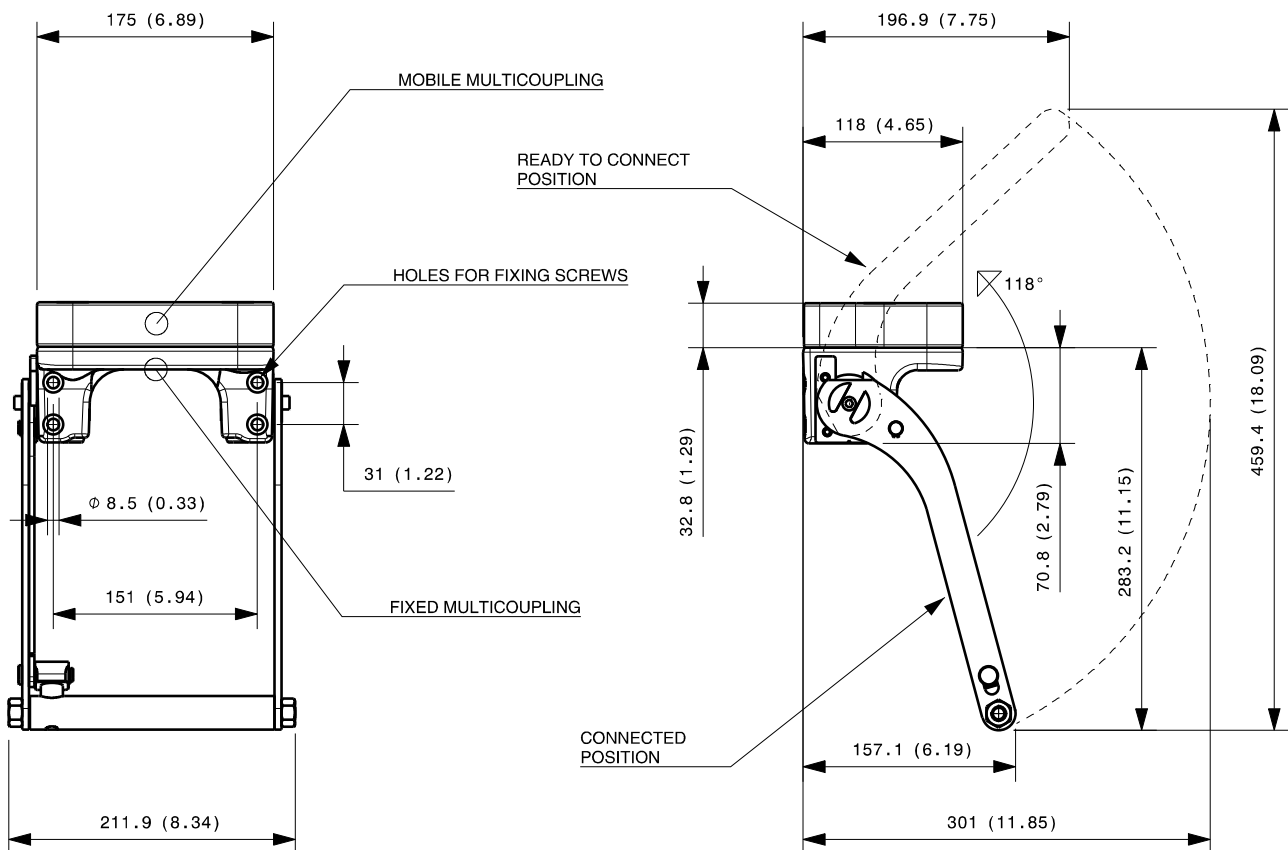

Dimensions in millimeters (inch)

Cap for fixed multicoupling 1,2 Kg

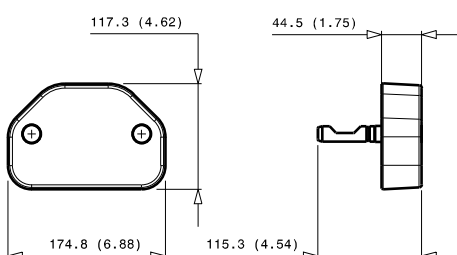

Parking station for mobile multicoupling 2,4 Kg

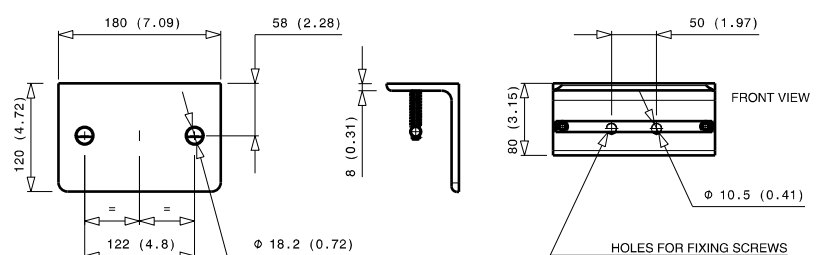

GR6 2B-4D-2EC

Previous description	Max. Resistance Body size	FAP9 (A) 3/8"	FAP13 (B) 1/2"	FAP15 (C) 5/8"	FAP17 (D) 3/4"	FAP21 (E) 1"	FAP30 (G) 1-1/2"
GR6LLZN	23000 N		2		4		



DRAWING

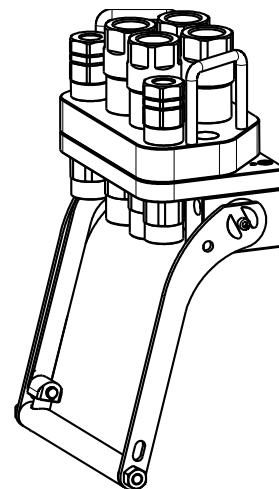

CONFIGURATIONS

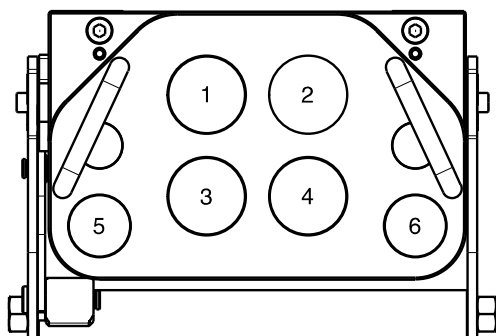

Pos	Possible configurations	
	Coupling size	Predisposition for electrical connector
1	FAP17ZN	-
2	FAP17ZN	-
3	FAP17ZN	-
4	FAP17ZN	-
5	FAP13ZN	YES
6	FAP13ZN	YES

MultiCoupling (couplings included)		
Code	Name	Description
870015067	MULTI COMPLETE GR6 1B-4D	1 FAQ13 1/2 BSP - 4 FAP17 1 BSP - CAP
870016004	MULTI COMPLETE GR6 1B-4D	1 FAP13 1/2 BSP - 4 FAP17 1 BSP - CAP
870016038	MULTI COMPLETE GR6 2B-4D	2 FAP13 3/4 BSP - 4 FAP17 1 BSP - CAP
870016066	MULTI COMPLETE GR6 1B-4D	1 FAP13 1/2 NPT - 3 FAP17 3/4 NPT - 1 FAQ17 1 NPT - CAP
870016105	MULTI FIX GR6 2D	2 FAP17 1 BSP
870016124	MULTI FIX GR6 2B-4D	2 FAP13 1/2 SAE - 4 FAP17 1 SAE
870016178	MULTI FIX GR6 2B-4D	2 FAP13 3/4 NPT - 4 FAP17 1 NPT
870016179	MULTI FIX GR6 2B-2D	2 FAP13 3/4 NPT - 2 FAP17 1 NPT
870016205	MULTI MOBILE GR6 2D	2 FAP17 1 BSP
870016224	MULTI MOBILE GR6 2B-4D	2 FAP13 1/2 SAE - 4 FAP17 1 SAE
870016278	MULTI MOBILE GR6 2B-4D	2 FAP13 3/4 NPT - 4 FAP17 1 NPT
870016279	MULTI MOBILE GR6 2B-2D	2 FAP13 3/4 NPT - 2 FAP17 1 NPT
870016204	MULTI MOBILE GR6 1B-4D	1 FAP13 1/2 BSP - 4 FAP17 1 BSP

MultiCoupling spare parts (couplings not included)	
Code	Name
806000338	MULTI FIX EMPTY GR6 2B-4D-2EC
806000339	MULTI MOBILE EMPTY GR6 2B-4D-2EC
815606262	CAP FIX MULTICOUPLING GR 218x140
815606263	PARKING STATION MOBILE MULTICOUPLING GR 218x150
815701056	SPARE KIT LEVER GROUP GR 250x256

Custom configurations available upon request

Fixed and mobile multicoupling

7,7 Kg and 5,0 Kg

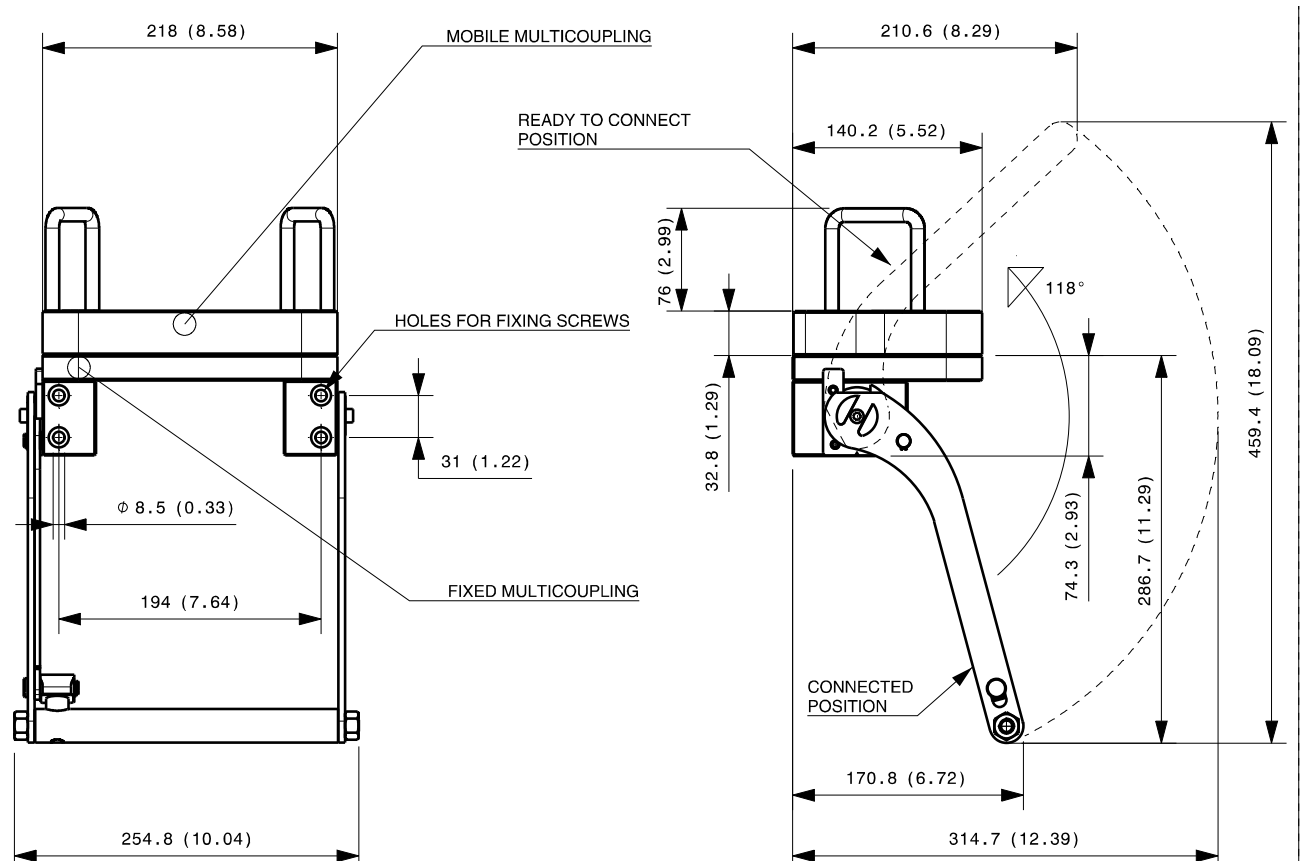

Dimensions in millimeters (inch)

Cap for fixed multicoupling 1,7 Kg

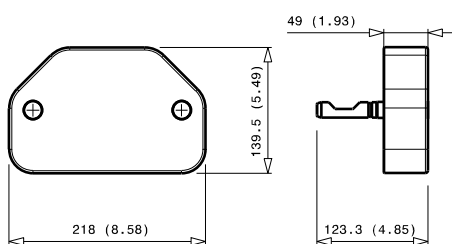

Parking station for mobile multicoupling 3,4 Kg

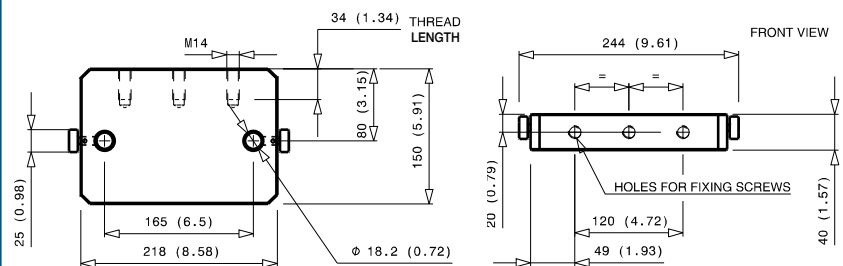

GR6 2A-4C-2EC

Previous description	Max. Resistance	FAP9 (A)	FAP13 (B)	FAP15 (C)	FAP17 (D)	FAP21 (E)	FAP30 (G)
Body size		3/8"	1/2"	5/8"	3/4"	1"	1-1/2"
GRM6ALZN	23000 N	2	D	4			



DRAWING

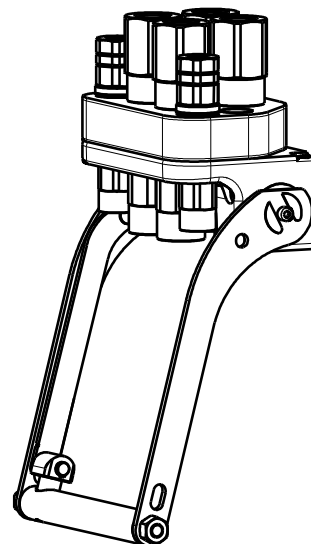

CONFIGURATIONS

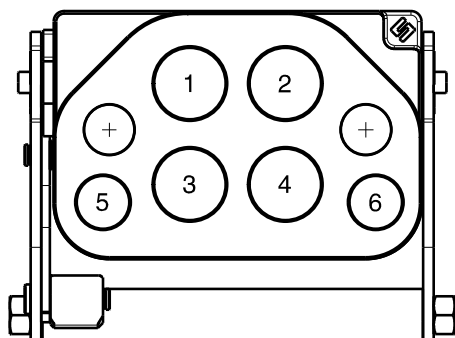

Possible configurations		
Pos	Coupling size	Predisposition for electrical connector
1	FAP15ZN	-
2	FAP15ZN	-
3	FAP15ZN	-
4	FAP15ZN	-
5	FAP9DZN	YES
6	FAP9DZN	YES

MultiCoupling (couplings included)

Code	Name	Description
870016019	MULTI COMPLETE GR6 2A-4C	2 FAP9D 3/8 BSP - 4 FAP15 3/4 BSP - CAP
870016119	MULTI FIX GR6 2A-4C	2 FAP9D 3/8 BSP - 4 FAP15 3/4 BSP
870016219	MULTI MOBILE GR6 2A-4C	2 FAP9D 3/8 BSP - 4 FAP15 3/4 BSP

MultiCoupling spare parts (couplings not included)

Code	Name
806000320	MULTI FIX EMPTY GR6 2A-4C-2EC
806000321	MULTI MOBILE EMPTY GR6 2A-4C-2EC
815606260	CAP FIX MULTICOUPLING GR 175x117 V02
815606261	PARKING STATION MOBILE MULTICOUPLING GR 180x120 V02
815701055	SPARE KIT LEVER GROUP GR 250x212

Custom configurations available upon request

Fixed and mobile multicoupling

5,6 Kg and 2,9 Kg

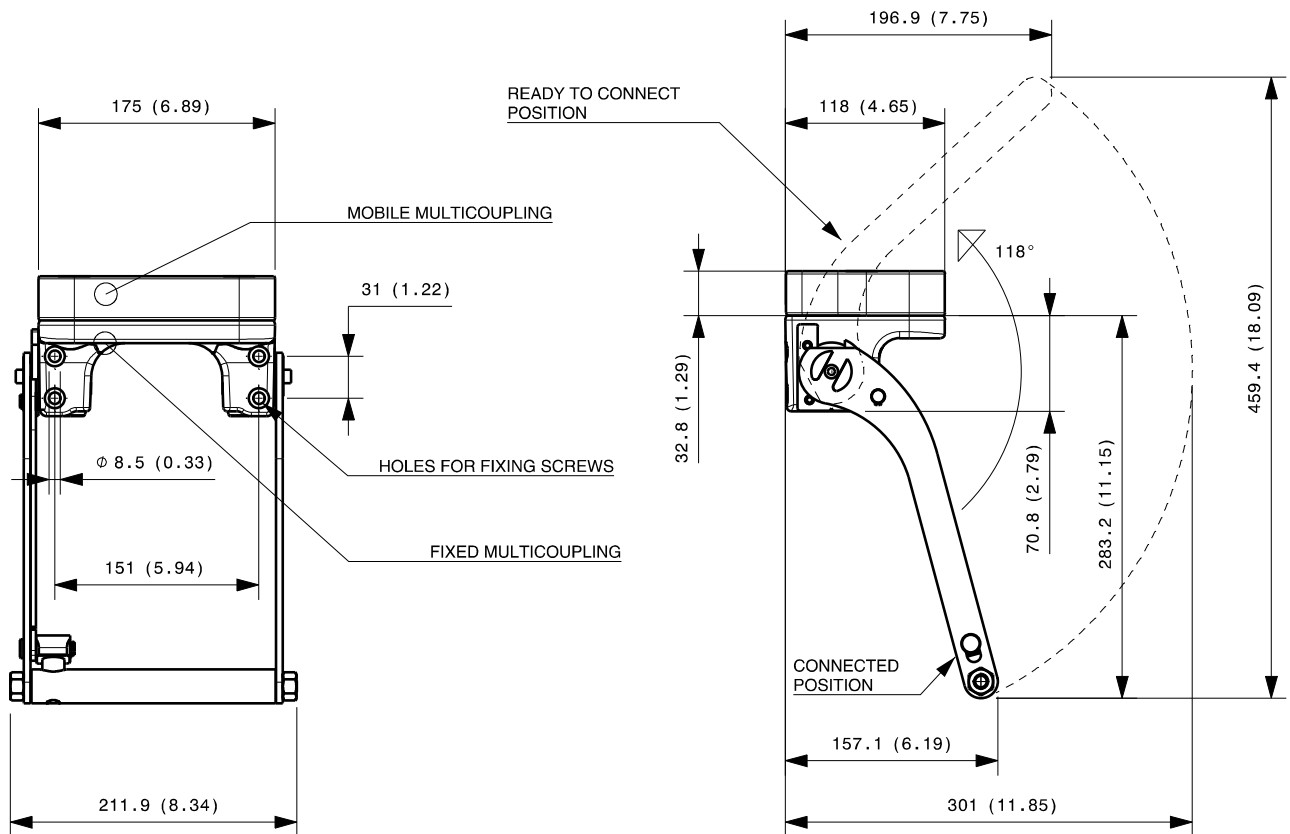

Dimensions in millimeters (inch)

Cap for fixed multicoupling 1,2 Kg

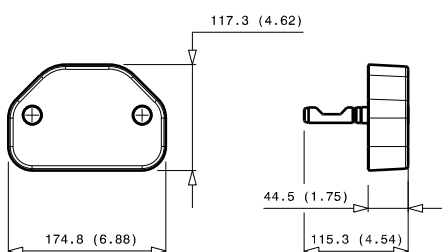

Parking station for mobile multicoupling 2,4 Kg

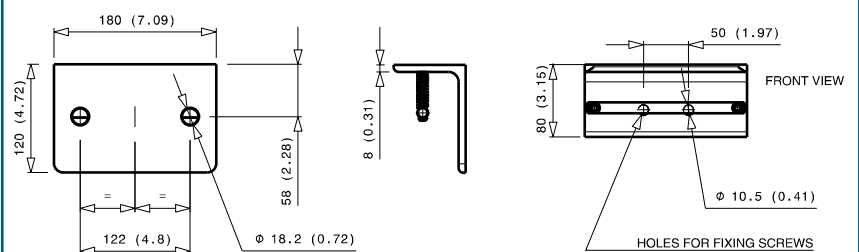

GR6 2A-1B-2D-1E-3EC

Previous description	Max. Resistance Body size	FAP9 (A) 3/8"	FAP13 (B) 1/2"	FAP15 (C) 5/8"	FAP17 (D) 3/4"	FAP21 (E) 1"	FAP30 (G) 1-1/2"
GR6AF	23000 N	2 D	1		2	1	



DRAWING

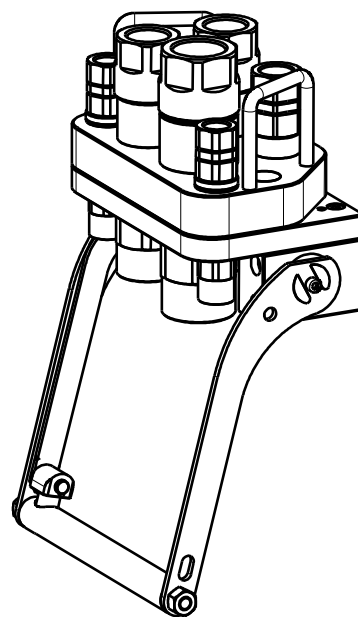

CONFIGURATIONS

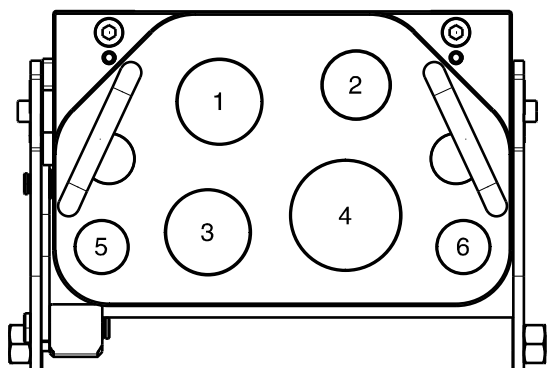

Possible configurations		
Pos	Coupling size	Predisposition for electrical connector
1	FAP17ZN	-
2	FAP13ZN	YES
3	FAP17ZN	-
4	FAP21ZN	-
5	FAP9DZN	YES
6	FAP9DZN	YES

MultiCoupling (couplings included)		
Code	Name	Description
870015076	MULTI COMPLETE GR6 1A-2D-1E	1 FAP9D 1/2 BSP - 2 FAP17 1 BSP - 1 FAP21 1-1/4 BSP - CAP
870015152	MULTI FIX GR6 2A-2D-1E	2 FAP9D 1/2 BSP - 2 FAP17 3/4 BSP - 1 FAP21 1-1/4 BSP
870015176	MULTI FIX GR6 1A-2D-1E	1 FAP9D 1/2 BSP - 2 FAP17 1 BSP - 1 FAP21 1-1/4 BSP
870016156	MULTI FIX GR6 1B-2D-1E	1 FAP13 1/2 BSP - 2 FAP17 3/4 BSP - 1 FAP21 1 BSP
870015276	MULTI MOBILE GR6 1A-2D-1E	1 FAP9D 1/2 BSP - 2 FAP17 1 BSP - 1 FAP21 1-1/4 BSP
870015252	MULTI MOBILE GR6 2A-2D-1E	2 FAP9D 1/2 BSP - 2 FAP17 3/4 BSP - 1 FAP21 1-1/4 BSP
870016255	MULTI MOBILE GR6 1D-1E	1 FAP17 3/4 BSP - 1 FAP21 1 BSP
870016256	MULTI MOBILE GR6 1B-2D-1E	1 FAP13 1/2 BSP - 2 FAP17 3/4 BSP - 1 FAP21 1 BSP

MultiCoupling spare parts (couplings not included)	
Code	Name
806000388	MULTI FIX EMPTY GR6 2A-1B-2D-1E-3EC
806000389	MULTI MOBILE EMPTY GR6 2A-1B-2D-1E -3EC
815606262	CAP FIX MULTICOUPLING GR 218x140
815606263	PARKING STATION MOBILE MULTICOUPLING GR 218x150
815701056	SPARE KIT LEVER GROUP GR 250x256

Custom configurations available upon request

Fixed and mobile multicoupling

7,5 Kg and 4,3 Kg

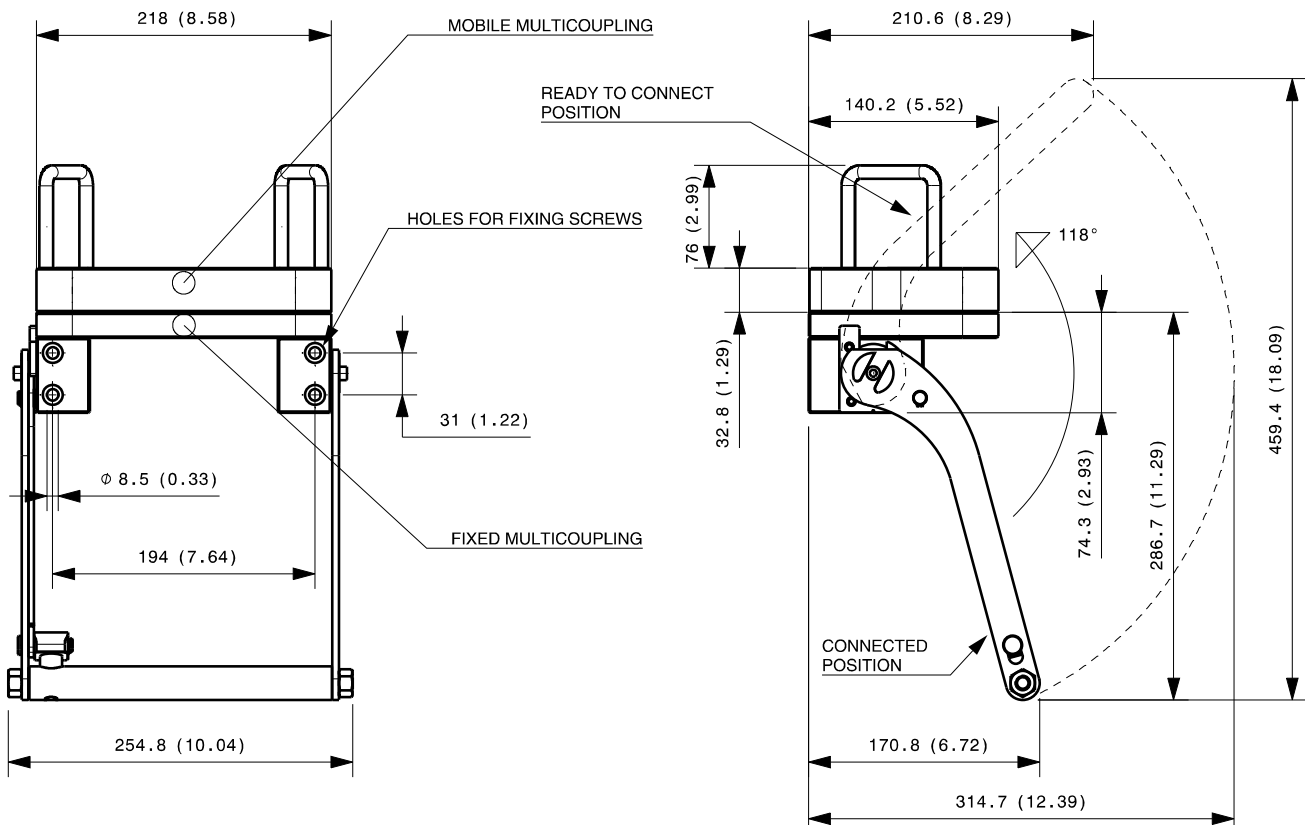

Dimensions in millimeters (inch)

Cap for fixed multicoupling 1,7 Kg

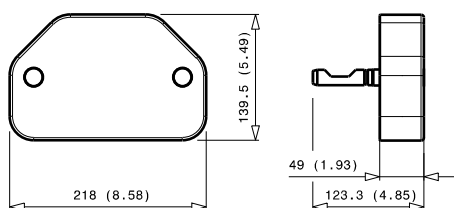

Parking station for mobile multicoupling 3,4 Kg

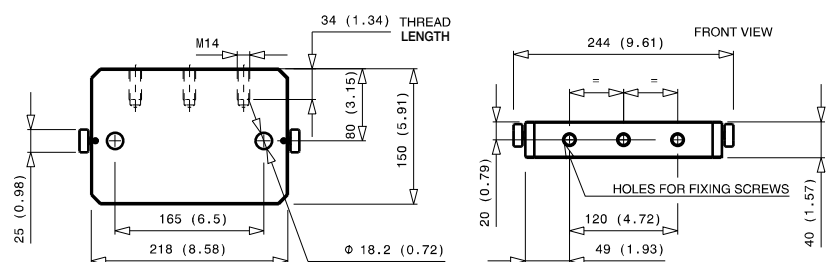

GR7 4A-3B-4EC

Previous description	Max. Resistance	FAP9 (A)	FAP13 (B)	FAP15 (C)	FAP17 (D)	FAP21 (E)	FAP30 (G)
Body size		3/8"	1/2"	5/8"	3/4"	1"	1-1/2"
GR7ABZN	23000 N	4 D	3				



DRAWING

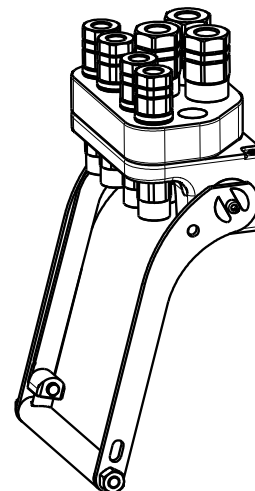

CONFIGURATIONS

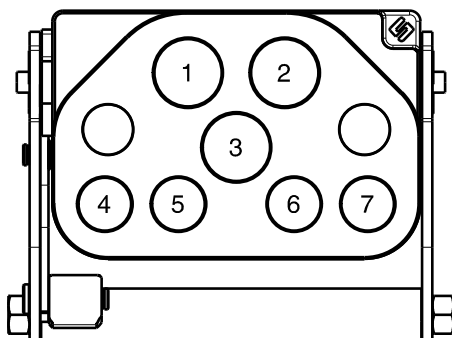

Pos	Possible configurations	
	Coupling size	Predisposition for electrical connector
1	FAP13ZN	-
2	FAP13ZN	-
3	FAP13ZN	-
4	FAP9DZN	YES
5	FAP9DZN	YES
6	FAP9DZN	YES
7	FAP9DZN	YES

MultiCoupling (couplings included)		
Code	Name	Description
870015085	MULTI COMPLETE GR7 2B-3EC	2 FAP13 1/2 BSP - 3EC6 - CAP
870016067	MULTI COMPLETE GR7 3A-3B-1EC	3 FAP9D 1/2 NPT - 3 FAP13 1/2 NPT - 1 EC7 - CAP
870016148	MULTI FIX GR7 2A-3B-2EC	2 FAP9D 1/2 BSP - 3 FAP13 1/2 BSP - 2EC6
870015153	MULTI FIX GR7 1A-2B-3EC	1 FAP9D 3/8 BSP - 2 FAP13 3/4 BSP - 3EC6
870015154	MULTI FIX GR7 3B-3EC	3 FAP13 1/2 BSP - 3EC6
870015185	MULTI FIX GR7 2B-3EC	2 FAP13 1/2 BSP - 3EC6
870015171	MULTI FIX GR7 3A-3B V01*	1 FAP9D 3/8 BSP - 2 FAP9D 3/8 BSP - 3 FAP13 1/2 BSP
870016248	MULTI MOBILE GR7 2A-3B-2EC	2 FAP9D 1/2 BSP - 3 FAP13 1/2 BSP - 2EC6
870015253	MULTI MOBILE GR7 1A-2B-3EC	1 FAP9D 3/8 BSP - 2 FAP13 3/4 BSP - 3EC6
870015254	MULTI MOBILE GR7 3B-3EC	3 FAP13 1/2 BSP - 3EC6
870015285	MULTI MOBILE GR7 2B-3EC	2 FAP13 1/2 BSP - 3EC6
870015271	MULTI MOBILE GR7 3A-3B V01*	1 FAP9D 3/8 BSP - 2 FAP9D 3/8 BSP - 3 FAP13 1/2 BSP

* V01 = lever length

MultiCoupling spare parts (couplings not included)	
Code	Name
806000328	MULTI FIX EMPTY GR7 4A-3B-4EC
806000380	MULTI FIX EMPTY GR7 4A-3B-4EC V01*
806000329	MULTI MOBILE EMPTY GR7 4A-3B-4EC
815606260	CAP FIX MULTICOUPLING GR 175x117 V02
815606261	PARKING STATION MOBILE MULTICOUPLING GR 180x120 V02
815701055	SPARE KIT LEVER GROUP GR 250x212
UPON REQUEST	SPECIFIC KIT FOR V01 MODEL

* V01 = lever length

Custom configurations available upon request

Fixed and mobile multicoupling

5,7 Kg and 2,9 Kg

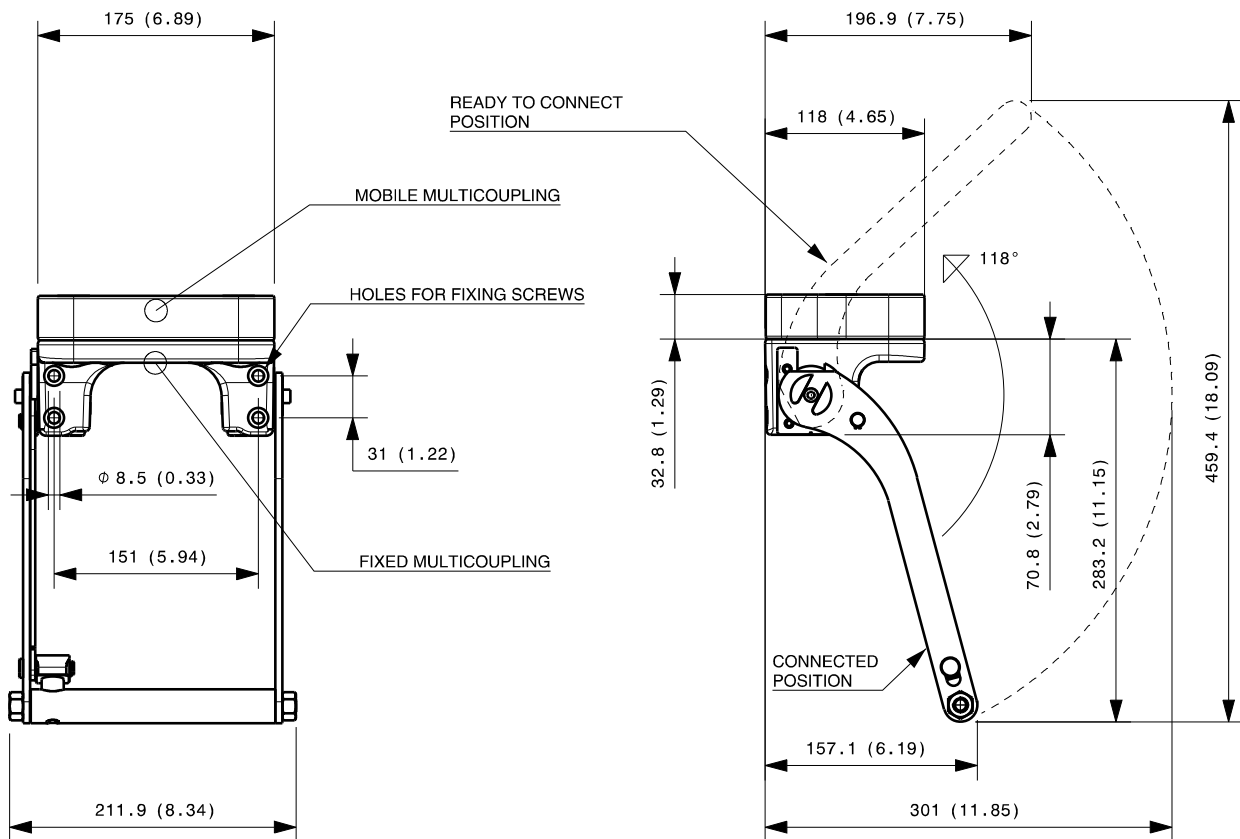

Available also model with shorter lever,
in case of need ask the drawing to info@stucchi.it

Dimensions in millimeters (inch)

Cap for fixed multicoupling 1,2 Kg

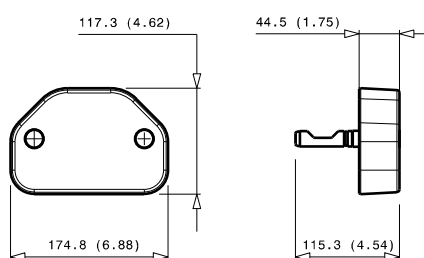

Parking station for mobile multicoupling 2,4 Kg

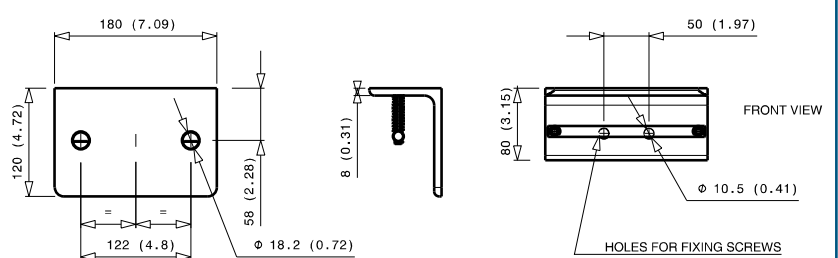

GRHP7 7A-4EC

Previous description	Max. Resistance	FAP9 (A)	FAP13 (B)	FAP15 (C)	FAP17 (D)	FAP21 (E)	FAP30 (G)
Body size		3/8"	1/2"	5/8"	3/4"	1"	1-1/2"
GR7ACZN	30000 N	4 D					
		3 HP					



DRAWING

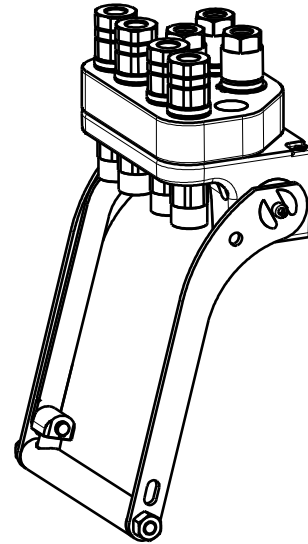

CONFIGURATIONS

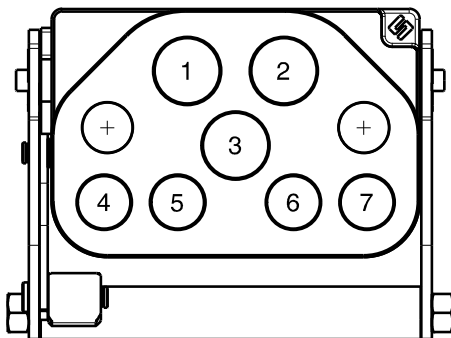

Possible configurations			
Pos	Coupling size	Predisposition for electrical connector	Pression type
1	FAP9-HP	-	High
2	FAP9-HP	-	High
3	FAP9-HP	-	High
4	FAP9DZN	YES	Medium
5	FAP9DZN	YES	Medium
6	FAP9DZN	YES	Medium
7	FAP9DZN	YES	Medium

MultiCoupling (couplings included)		
Code	Name	Description
870016020	MULTI COMPLETE GRHP7 7A	4 FAP9D 3/8 BSP - 3 FAP9HP 3/8 NPT - CAP
870016120	MULTI FIX GRHP7 7A	4 FAP9D 3/8 BSP - 3 FAP9HP 3/8 NPT
870016220	MULTI MOBILE GRHP7 7A	4 FAP9D 3/8 BSP - 3 FAP9HP 3/8 NPT

MultiCoupling spare parts (couplings not included)	
Code	Name
806000330	MULTI FIX EMPTY GRHP7 7A-4EC
806000331	MULTI MOBILE EMPTY GRHP7 7A-4EC
815606260	CAP FIX MULTICOUPLING GR 175x117 V02
815606261	PARKING STATION MOBILE MULTICOUPLING GR 180x120 V02
815701055	SPARE KIT LEVER GROUP GR 250x212

Custom configurations available upon request

Fixed and mobile multicoupling

5,6 Kg and 2,9 Kg

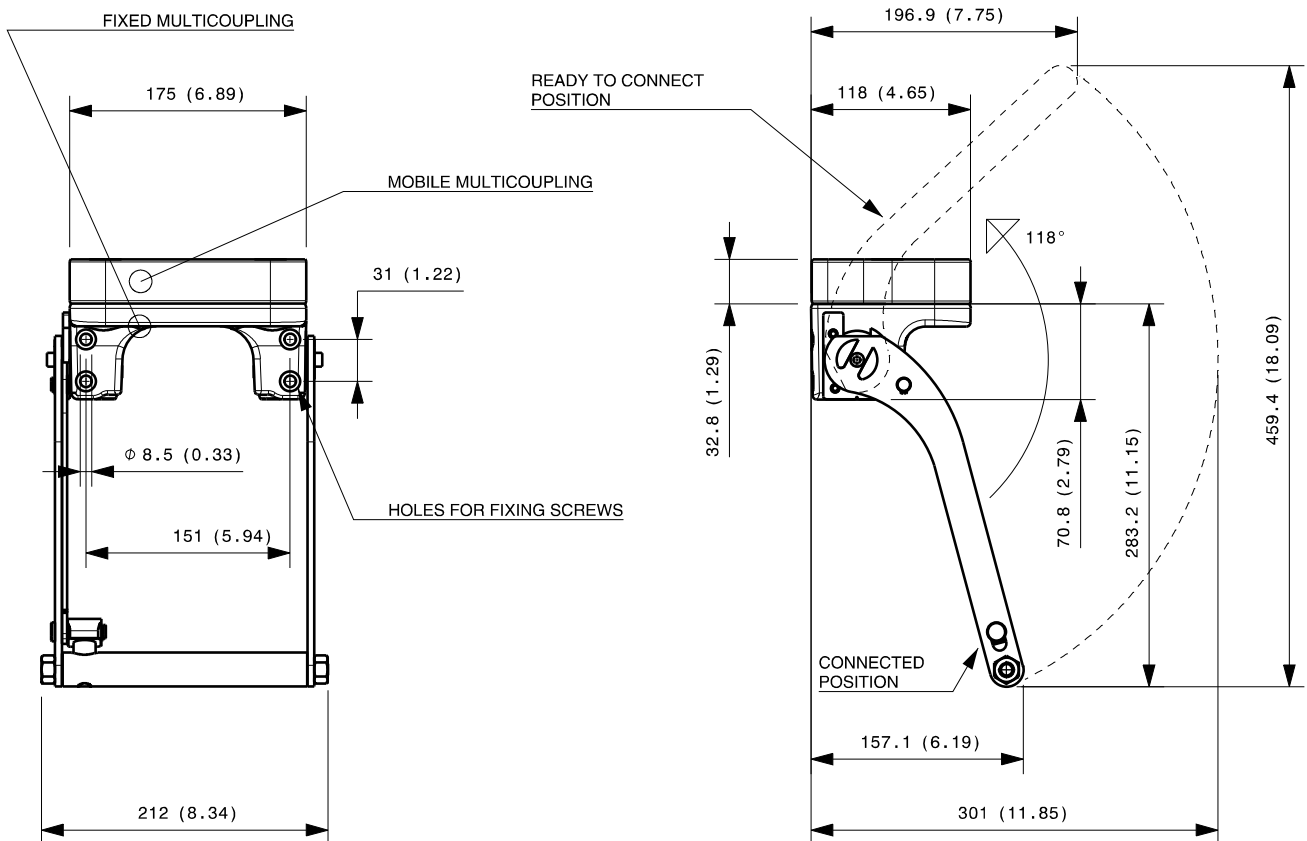

Dimensions in millimeters (inch)

Cap for fixed multicoupling 1,2 Kg

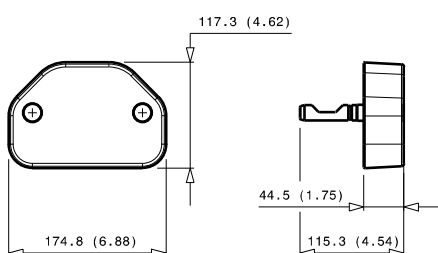

Parking station for mobile multicoupling 2,3 Kg

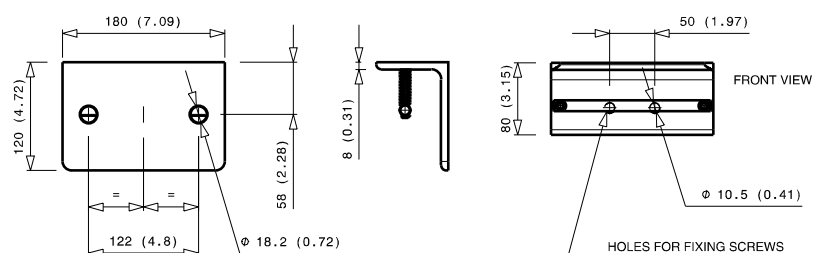

GR7 4A-1B-2D-4EC

Previous description	Max. Resistance	FAP9 (A)	FAP13 (B)	FAP15 (C)	FAP17 (D)	FAP21 (E)	FAP30 (G)
Body size		3/8"	1/2"	5/8"	3/4"	1"	1-1/2"
GR7AAZN	23000 N	4 D	1		2		



DRAWING



CONFIGURATIONS

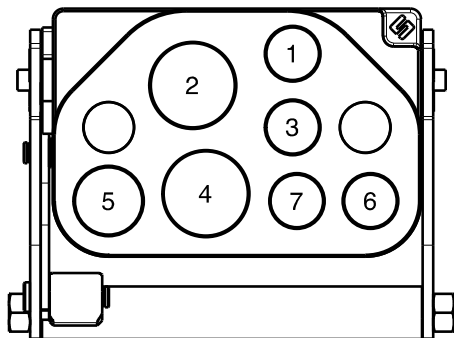

Possible configurations		
Pos	Coupling size	Predisposition for electrical connector
1	FAP9DZN	YES
2	FAP17ZN	-
3	FAP9DZN	YES
4	FAP17ZN	-
5	FAP13ZN	-
6	FAP9DZN	YES
7	FAP9DZN	YES

MultiCoupling (couplings included)		
Code	Name	Description
870016006	MULTI COMPLETE GR7 3A-1B-2D-1EC	1 FAP9D 1/4 BSP - 2 FAP9D 3/8 BSP - 1 FAP13 1/2 BSP - 2 FAP17 1 BSP - 1EC7 - CAP
870016075	MULTI COMPLETE GR7 4A-2D	4 FAP9D 3/8 NPT - 2 FAP17 3/4 NPT - CAP
870016106	MULTI FIX GR7 3A-1B-2D-1EC	1 FAP9D 1/4 BSP - 2 FAP9D 3/8 BSP - 1 FAP13 1/2 BSP - 2 FAP17 1 BSP - 1EC7
870016139	MULTI FIX GR7 1B-2D-4EC	1 FAP13 1/2 BSP - 2 FAP17 1 BSP - 4 EC6
870016206	MULTI MOBILE GR7 3A-1B-2D-1EC	1 FAP9D 1/4 BSP - 2 FAP9D 3/8 BSP - 1 FAP13 1/2 BSP - 2 FAP17 1 BSP - 1EC7
870016239	MULTI MOBILE GR7 1B-2D-4EC	1 FAP13 1/2 BSP - 2 FAP17 1 BSP - 4 EC6

MultiCoupling spare parts (couplings not included)		
Code	Name	
806000324	MULTI FIX EMPTY GR7 4A-1B-2D-4EC	
806000325	MULTI MOBILE EMPTY GR7 4A-1B-2D-4EC	
815606260	CAP FIX MULTICOUPLING GR 175x117 V02	
815606261	PARKING STATION MOBILE MULTICOUPLING GR 180x120 V02	
815701055	SPARE KIT LEVER GROUP GR 250x212	

Custom configurations available upon request

Fixed and mobile multicoupling

5,4 Kg and 2,6 Kg

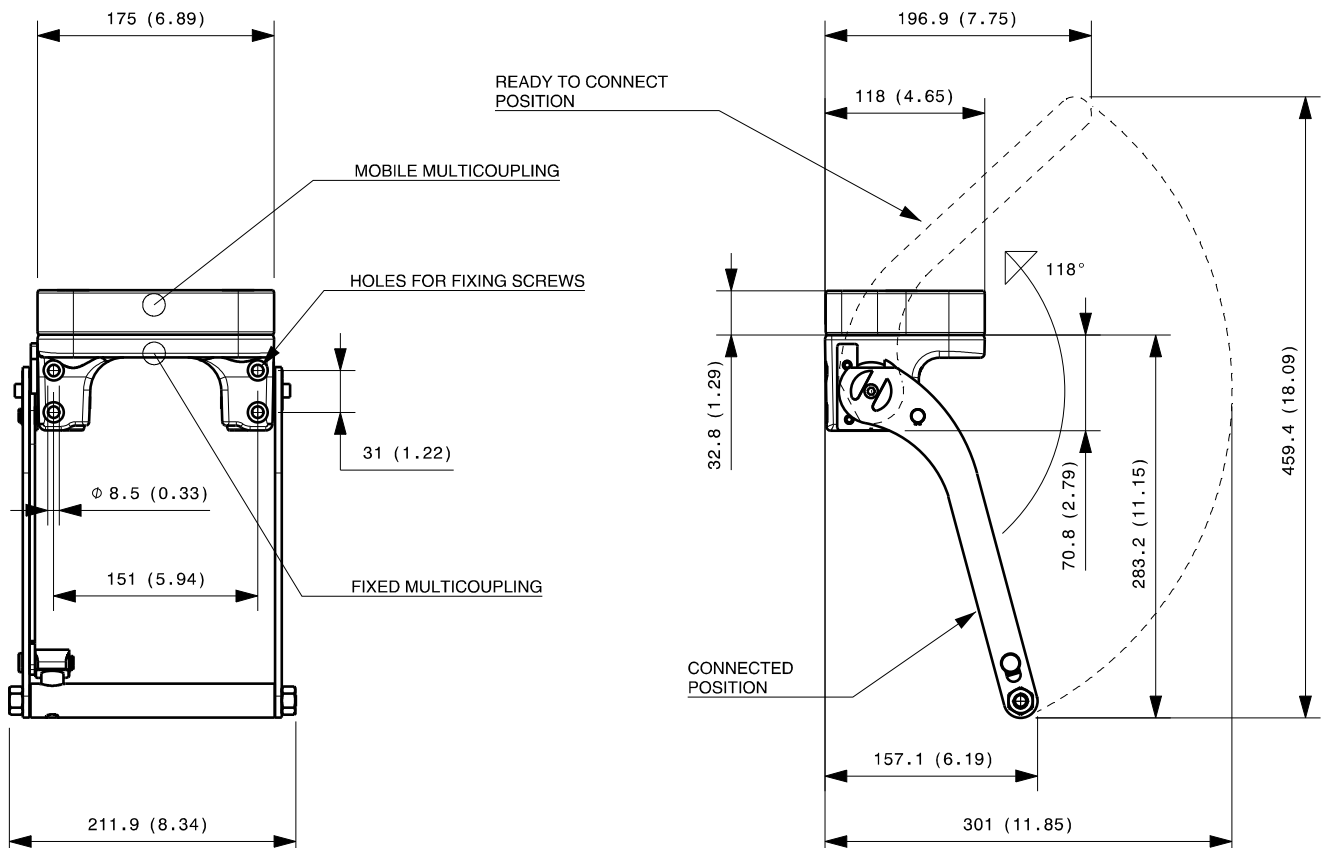

Dimensions in millimeters (inch)

Cap for fixed multicoupling 1,2 Kg

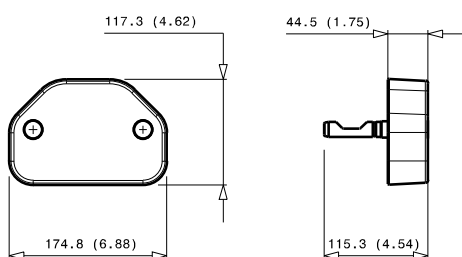

Parking station for mobile multicoupling 2,4 Kg

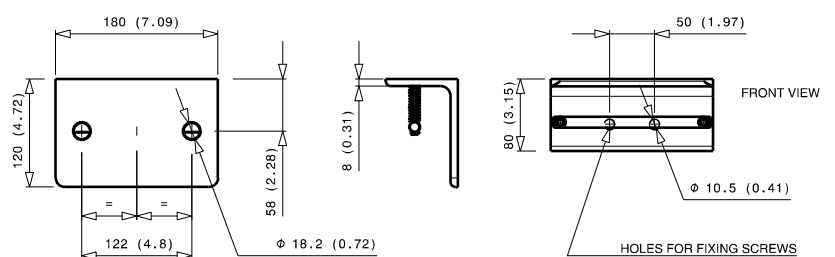

GR8 6A-2B-6EC

Previous description	Max. Resistance	FAP9 (A)		FAP13 (B)	FAP15 (C)	FAP17 (D)	FAP21 (E)	FAP30 (G)
Body size		3/8"	D	1/2"	5/8"	3/4"	1"	1-1/2"
GR8ABZN	30000 N	6	D	2				



DRAWING



CONFIGURATIONS

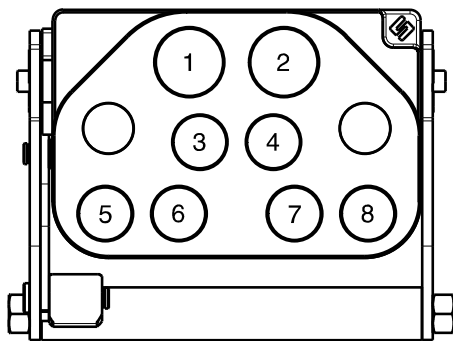

Pos	Possible configurations	
	Coupling size	Predisposition for electrical connector
1	FAP13ZN	-
2	FAP13ZN	-
3	FAP9DZN	YES
4	FAP9DZN	YES
5	FAP9DZN	YES
6	FAP9DZN	YES
7	FAP9DZN	YES
8	FAP9DZN	YES

MultiCoupling (couplings included)

Code	Name	Description
870015087	MULTI COMPLETE GR8 6A-2B	6 FAP9D 3/8 BSP - 1 FAP13 1/2 BSP - 1 FAP13 3/4 BSP - CAP
870016059	MULTI COMPLETE GR8 6A-2B	6 FAP9D 3/8 BSP - 2 FAP13 1/2 BSP - CAP
870016062	MULTI COMPLETE GR8 4A-2B	2 FAP9D 3/8 NPT - 2 FAP9D 1/2 NPT - 2 FAP13 3/4 NPT - CAP
870015187	MULTI FIX GR8 6A-2B	6 FAP9D 3/8 BSP - 1 FAP13 1/2 BSP - 1 FAP13 3/4 BSP
870016150	MULTI FIX GR8 6A-2B	6 FAP9D 1/2 BSP - 2 FAP13 1/2 BSP
870016168	MULTI FIX GR8 5A-1B	5 FAP9D 3/8 BSP - 1 FAP13 3/4 BSP
870015187	MULTI FIX GR8 6A-2B	6 FAP9D 3/8 BSP - 1 FAP13 1/2 BSP - 1 FAP13 3/4 BSP
870015287	MULTI MOBILE GR8 6A-2B	6 FAP9D 3/8 BSP - 1 FAP13 1/2 BSP - 1 FAP13 3/4 BSP
870016250	MULTI MOBILE GR8 6A-2B	6 FAP9D 1/2 BSP - 2 FAP13 1/2 BSP
870016268	MULTI MOBILE GR8 5A-1B	5 FAP9D 3/8 BSP - 1 FAP13 3/4 BSP

MultiCoupling spare parts (couplings not included)

Code	Name
806000334	MULTI FIX EMPTY GR8 6A-2B-6EC
806000335	MULTI MOBILE EMPTY GR8 6A-2B-6EC
815606260	CAP FIX MULTICOUPLING GR 175x117 V02
815606261	PARKING STATION MOBILE MULTICOUPLING GR 180x120 V02
815701055	SPARE KIT LEVER GROUP GR 250x212

Custom configurations available upon request

Fixed and mobile multicoupling

5,7 Kg and 2,8 Kg

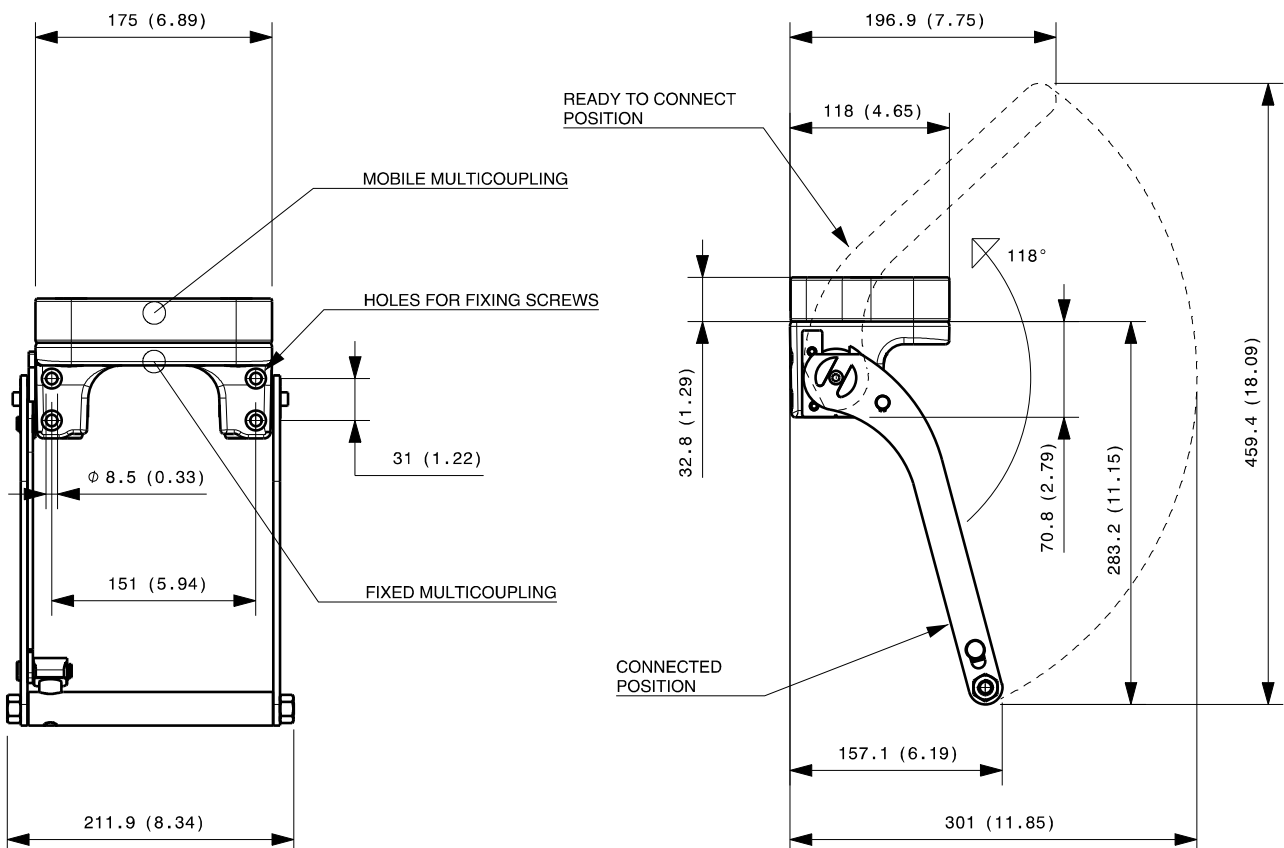

Dimensions in millimeters (inch)

Cap for fixed multicoupling 1,1 Kg

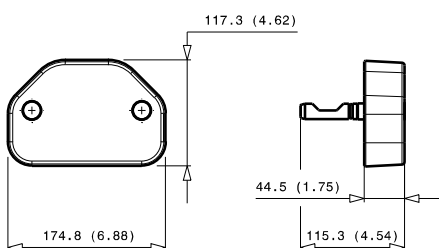

Parking station for mobile multicoupling 2,4 Kg

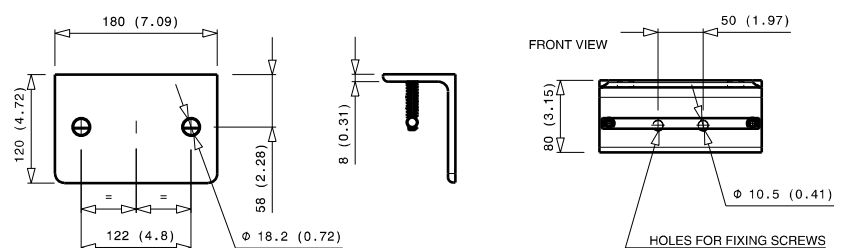

GR8 7A-1D-7EC

Previous description	Max. Resistance	FAP9 (A)	FAP13 (B)	FAP15 (C)	FAP17 (D)	FAP21 (E)	FAP30 (G)
Body size		3/8"	1/2"	5/8"	3/4"	1"	1-1/2"
GR8AAZN	23000 N	7	D		1		



DRAWING

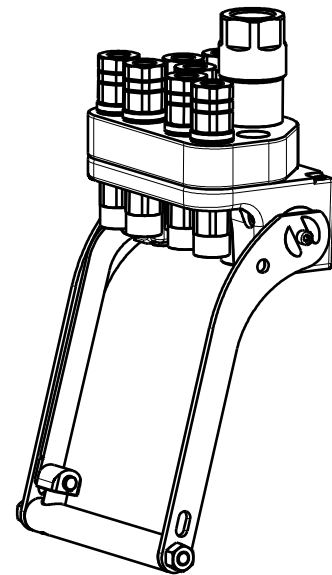

CONFIGURATIONS

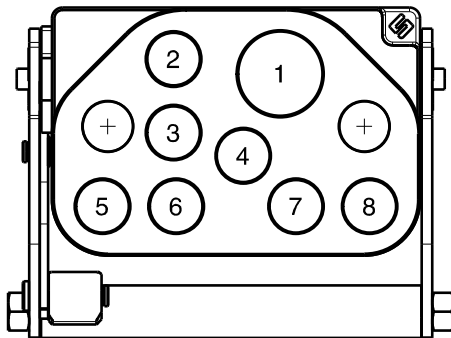

Possible configurations		
Pos	Coupling size	Predisposition for electrical connector
1	FAP17ZN	-
2	FAP9DZN	YES
3	FAP9DZN	YES
4	FAP9DZN	YES
5	FAP9DZN	YES
6	FAP9DZN	YES
7	FAP9DZN	YES
8	FAP9DZN	YES

MultiCoupling (couplings included)		
Code	Name	Description
870016021	MULTI COMPLETE GR8 7A-1D	7 FAP9D 3/8 BSP - 1 FAP17 1 BSP - CAP
870016070	MULTI COMPLETE GR8 6A-1D-1EC	6 FAP9D 3/8 BSP - 1 FAP17 3/4 BSP - 1 EC7 - CAP
870016121	MULTI FIX GR8 7A-1D	7 FAP9D 3/8 BSP - 1 FAP17 1 BSP
870016221	MULTI MOBILE GR8 7A-1D	7 FAP9D 3/8 BSP - 1 FAP17 1 BSP
870016271	MULTI MOBILE GR8 6A-1D	6 FAP9D 3/8 BSP - 1 FAP17 3/4 BSP

MultiCoupling spare parts (couplings not included)		
Code	Name	
806000332	MULTI FIX EMPTY GR8 7A-1D-7EC	
806000333	MULTI MOBILE EMPTY GR8 7A-1D-7EC	
815606260	CAP FIX MULTICOUPLING GR 175x117 V02	
815606261	PARKING STATION MOBILE MULTICOUPLING GR 180x120 V02	
815701055	SPARE KIT LEVER GROUP GR 250x212	

Custom configurations available upon request

Fixed and mobile multicoupling

5,7 Kg and 2,8 Kg

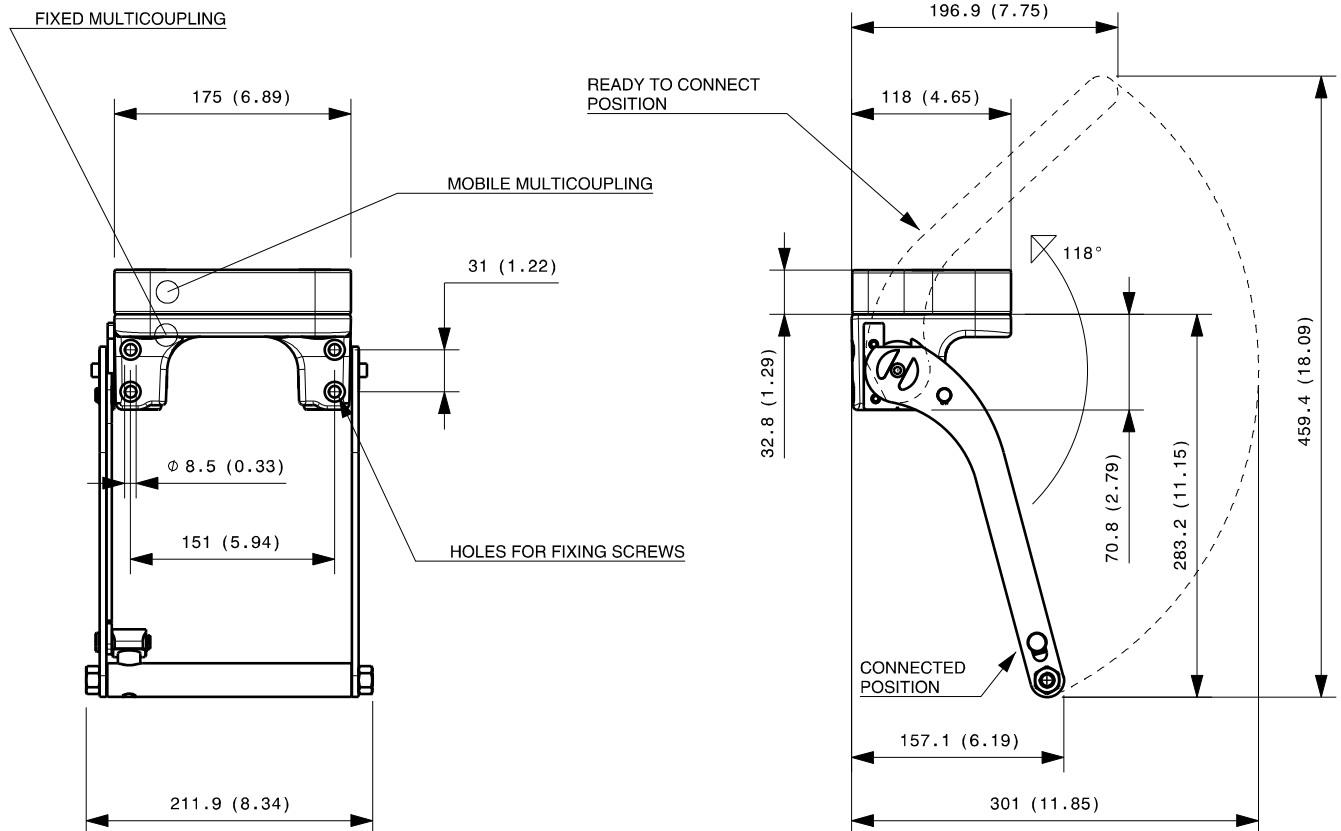

Dimensions in millimeters (inch)

Cap for fixed multicoupling 1,1 Kg

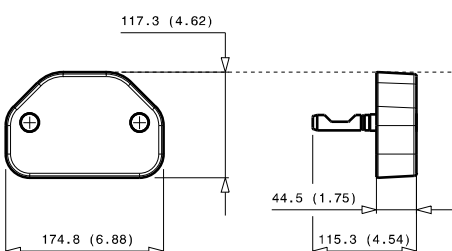

Parking station for mobile multicoupling 2,3 Kg

2,3 Kg

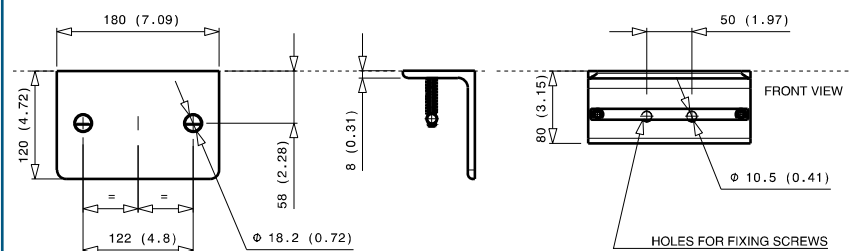

GR10 10A-2EC

Previous description	Max. Resistance	FAP9 (A)	FAP13 (B)	FAP15 (C)	FAP17 (D)	FAP21 (E)	FAP30 (G)
Body size		3/8"	1/2"	5/8"	3/4"	1"	1-1/2"
GR10-9ZN	23000 N	10	D				



DRAWING

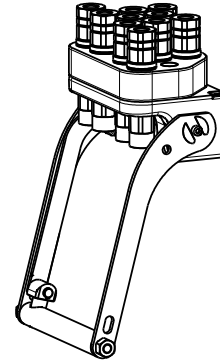

CONFIGURATIONS

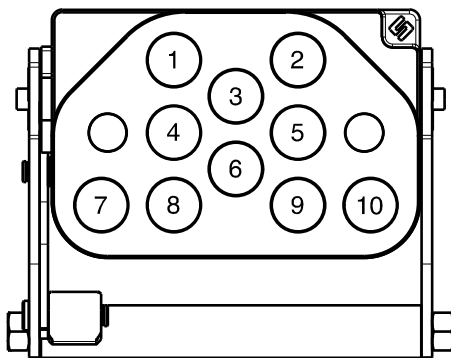

Pos	Possible configurations	
	Coupling size	Predisposition for electrical connector
1	FAP9DZN	-
2	FAP9DZN	-
3	FAP9DZN	-
4	FAP9DZN	-
5	FAP9DZN	-
6	FAP9DZN	-
7	FAP9DZN	YES
8	FAP9DZN	-
9	FAP9DZN	-
10	FAP9DZN	YES

MultiCoupling (couplings included)

Code	Name	Description
870004022	MULTI COMPLETE GR10 8A	8 FAP9D 3/8 BSP - CAP
870004023	MULTI COMPLETE GR10 10A	10 FAP9D 1/2 BSP - CAP
870004024	MULTI COMPLETE GR10 10A	10 FAP9D 3/8 BSP - CAP
870004026	MULTI COMPLETE GR10 10A	10 FAP9D 1/4 BSP - CAP
870004028	MULTI COMPLETE GR10 8A	8 FAP9D 1/2 BSP - CAP
870004029	MULTI COMPLETE GR10 10A	8 FAP9D 3/8 BSP -2 FAP9D 1/2 BSP - CAP
870004032	MULTI COMPLETE GR10 9A	9 FAP9D 1/2 BSP - CAP
870004033	MULTI COMPLETE GR10 9A	9 FAP9D 3/8 BSP - CAP
870004034	MULTI COMPLETE GR10 10A	10 FAP9D 3/8 SAE - CAP
870004025	MULTI COMPLETE GR10 8A V03**	8 FAP9DSD 1/2 BSP - CAP
870004036	MULTI COMPLETE GR10 10A V03**	10 FAP9DSD 1/2 BSP - CAP
870004123	MULTI FIX GR10 10A	10 FAP9D 1/2 BSP
870004125	MULTI FIX GR10 8A V03**	8 FAP9DSD 1/2 BSP
870004135	MULTI FIX GR10 10A	10 FAP9D 3/8 NPT
870004136	MULTI FIX GR10 10A V03**	10 FAP9DSD 1/2 BSP
870004223	MULTI MOBILE GR10 10A	10 FAP9D 1/2 BSP
870004224	MULTI MOBILE GR10 10A	10 FAP9D 3/8 BSP
870004225	MULTI MOBILE GR10 8A V03**	8 FAP9DSD 1/2 BSP
870004235	MULTI MOBILE GR10 10A	10 FAP9D 3/8 NPT
870004236	MULTI MOBILE GR10 10A V03**	10 FAP9DSD 1/2 BSP

MultiCoupling spare parts (couplings not included)

Code	Name
806000302	MULTI FIX EMPTY GR10 10A-2EC
806000303	MULTI MOBILE EMPTY GR10 10A-2EC
806000304	MULTI FIX EMPTY GR10 10A-2EC V01*
806000372	MULTI FIX EMPTY GR10 10A-2EC V03**
806000373	MULTI MOBILE EMPTY GR10 10A-2EC V03**

* V01 = lever length | ** V03 = seal on plate

MultiCoupling spare parts

Code	Name
815606258	CAP FIX MULTICOUPLING GR 175X117 V01*
815606286	CAP FIX MULTICOUPLING GR 175X117 V03**
815606259	PARKING STATION MOBILE MULTICOUPLING GR 180x120 V01*
815700999	SPARE KIT LEVER GROUP GR 250x212
UPON REQUEST	SPECIFIC KIT FOR V01* MODEL
815700996	SPARE KIT 1 F COUPLING+OR FOR V03 MODEL
815700997	SPARE KIT 1 M COUPLING+OR FOR V03 MODEL
815700998	SPECIFIC KIT FOR V03** MODEL

Fixed and mobile multicoupling

5,7 Kg and 2,7 Kg

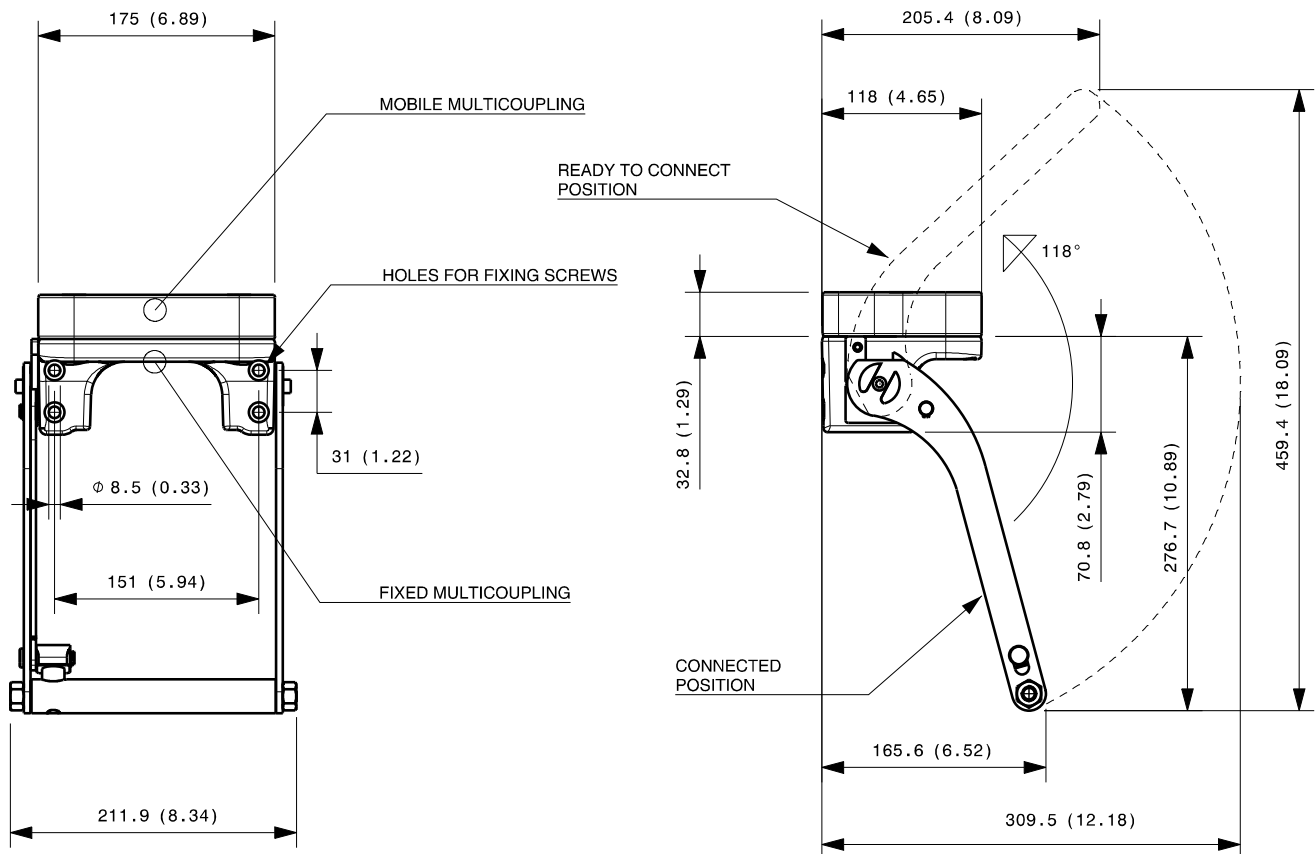

Available also model with shorter lever or seal on fix multicoupling, in case of need ask the drawing to info@stucchi.it

Dimensions in millimeters (inch)

Cap for fixed multicoupling 1,1 Kg

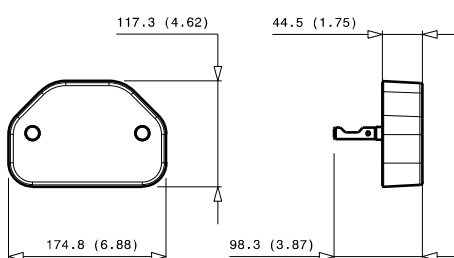

Parking station for mobile multicoupling 2,2 Kg

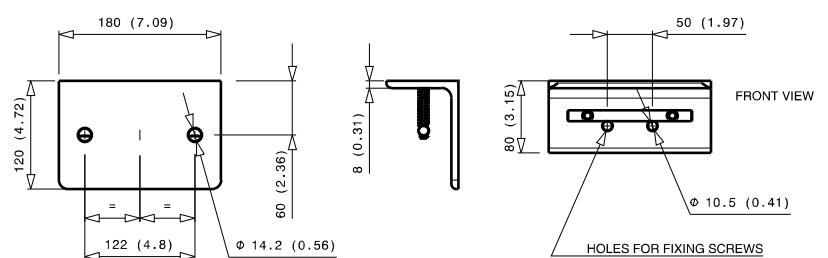

GR10 10B-2EC

Previous description	Max. Resistance Body size	FAP9 (A) 3/8"	FAP13 (B) 1/2"	FAP15 (C) 5/8"	FAP17 (D) 3/4"	FAP21 (E) 1"	FAP30 (G) 1-1/2"
GR10-13ZN	23000 N		10				



DRAWING

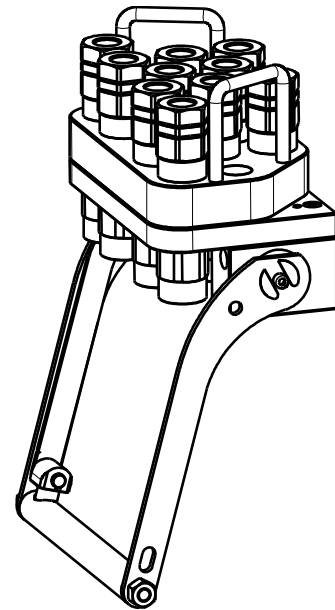

CONFIGURATIONS

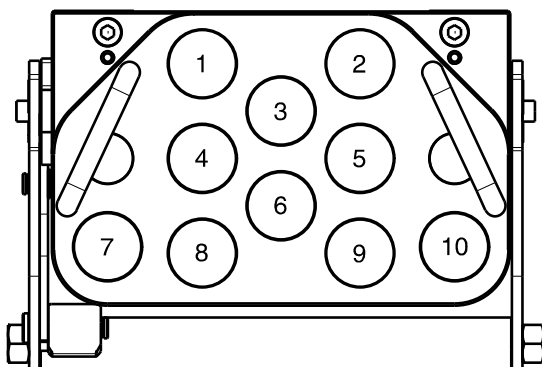

Possible configurations		
Pos	Coupling size	Predisposition for electrical connector
1	FAP13ZN	-
2	FAP13ZN	-
3	FAP13ZN	-
4	FAP13ZN	-
5	FAP13ZN	-
6	FAP13ZN	-
7	FAP13ZN	YES
8	FAP13ZN	-
9	FAP13ZN	-
10	FAP13ZN	YES

MultiCoupling (couplings included)		
Code	Name	Description
870010008	MULTI COMPLETE GR10 10B	10 FAP13 3/4 BSP - CAP
870010009	MULTI COMPLETE GR10 10B	10 FAP13 1/2 BSP - CAP
870010010	MULTI COMPLETE GR10 10B	10 FAP13 1/2 NPT - CAP
870010109	MULTI FIX GR10 10B	10 FAP13 1/2 BSP
870010111	MULTI FIX GR10 8B	4 FAP13 1/2 SAE - 4 FAP13 3/4 SAE
870010112	MULTI FIX GR10 8B	8 FAP13 3/4 SAE
870010209	MULTI MOBILE GR10 10B	10 FAP13 1/2 BSP
870010211	MULTI MOBILE GR10 8B	4 FAP13 1/2 SAE - 4 FAP13 3/4 SAE

MultiCoupling spare parts (couplings not included)		
Code	Name	Description
806000336	MULTI FIX EMPTY GR10 10B-2EC	
806000337	MULTI MOBILE EMPTY GR10 10B-2EC	
815606262	CAP FIX MULTICOUPLING GR 218x140	
815606263	PARKING STATION MOBILE MULTICOUPLING GR 218x150	
815701056	SPARE KIT LEVER GROUP GR 250x256	

Custom configurations available upon request

Fixed and mobile multicoupling

7,5 Kg and 4,3 Kg

GR

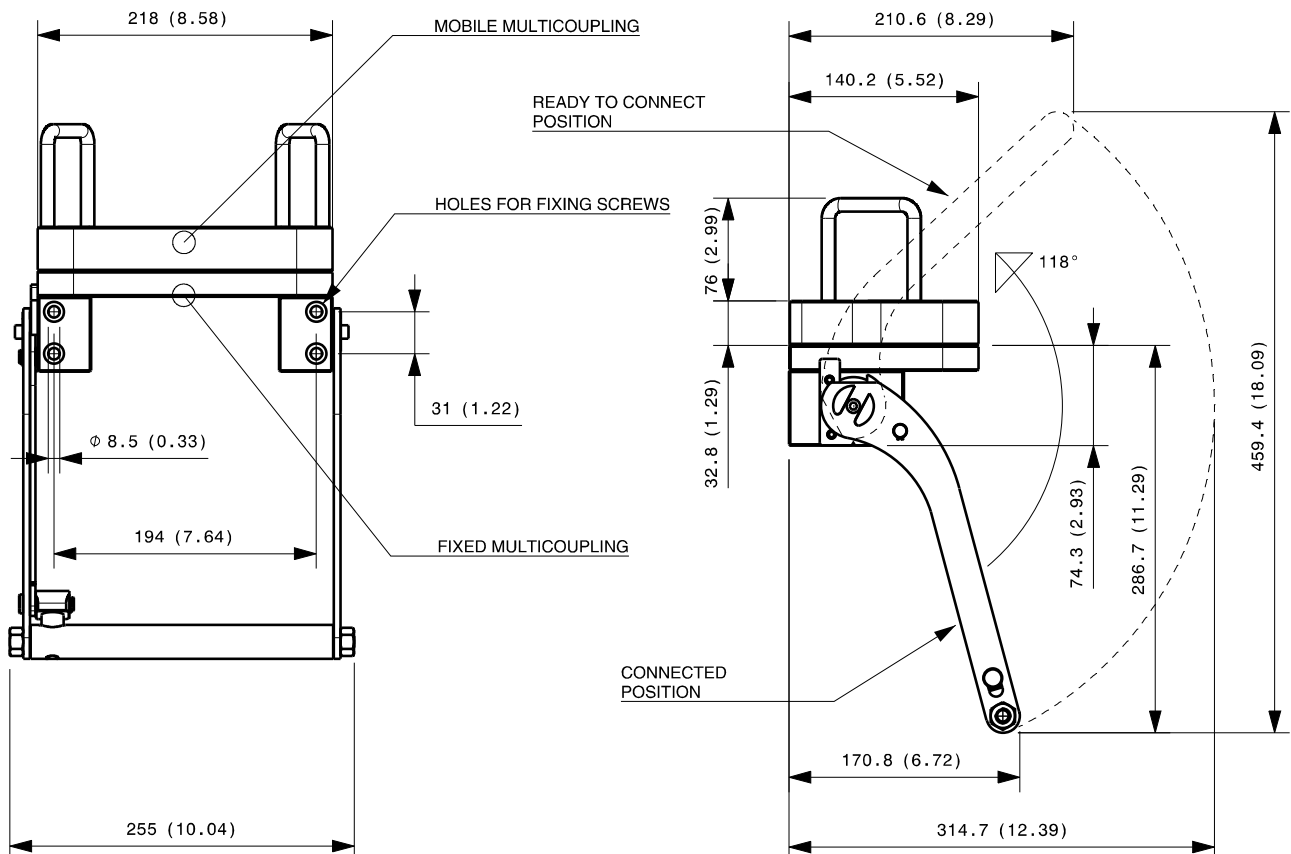

Dimensions in millimeters (inch)

Cap for fixed multicoupling 1,7 Kg

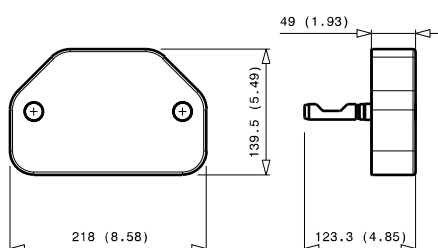

Parking station for mobile multicoupling 3,4 Kg

